

MEASURE UP TO BE THE BEST

For over 40 years Dent Fix has supplied the collision repair industries with quality, innovative tools to exceed the demands of PBE professionals.



5 METER TRAM
DENDF-3TC5



ELIMINATOR
DENDF-700DX



ALUSPOT DELUXE
DENDF-900DXE



ALUSPOT MINI
DENDF-900B



ULTRA DING MASSAGER
DENDF-DM555UDX



EZ NITRO GENERATOR
DENDF-EZN1G



ALUMINUM

POM Dolly Set DENDF-AB712
Rubber Dolly Set DENDF-AB711
Push/Pull Riveter DENDF-SPR69
Blind Rivet Adapt. DENDF-SPRBRAD



STEEL

Spot Weld Drill DENDF-15DX
MAXI Bridge DENDF-505BP
MAXI Massager DENDF-505DM
Fender Puller DENDF-HD0140



PLASTIC

Sensor Hole Maker DENDF-EZ10
EZAP Anti-Static DENDF-EZAP
Panel Popper Set DENDF-621TPS
Hot Stapler DENDF-800BR



PAINT & BODY | tools Index:

Air Brushes & Specialty Sprayers	1332-1333
Pressure Pots	1333
Spray Gun Kits	1334-1335
Spray Guns	SATA 1336-1347
Cups	<small>Spray Equipment</small> 1347-1348
Regulators	1349
Gun Holders	1350
Paint Gun Accessories	1350
Air Filtration	1351-1352
Breathing Protection	1353
Paint Suits and Body Protection	1354
Paint Preparation Cups	1355
Tape	1356-1357
Color Match Lights	1357
Paint Drying, Curing & Shaking	1358-1359
Masks	1360-1361
Masking Paper / Covers	1362-1364
Work Trees and Stands	1364-1367
Tire Steps	1366
Sanding Blocks and Boards	1368-1370
Backing Pads	1370-1373
Sanding Pads	1373-1374
Nib Files	1374
Eraser Pad Tools	1374
Adhesives	1375-1377
Chains and Slings	1378
Body Hammers	1379-1382
Body Spoons	1382-1384
Paintless Dent Removal Tools	DENT FIX 1384-1387
Stud Welder Kits and Welding Studs	1388-1390
Pulling Tabs & Studs	1391
Clamps	1392-1395
Body Pullers	1395-1397
Dent Pullers	1397-1398
Hooks	1398-1400
Frame Measurement	1400-1401
Riveters, Kits and Rivets	1402-1407
Body Panel	1408-1409
Plastic and Fiberglass Repair	1410-1414
Body Sheet Metal	1415-1419
Car Care/Motorcycle Care	
Applicators, Car Wash Products, Wheel & Tire Products, Leather & Vinyl Products, Waxes & Polishes, Compounds,	1419-1436
Buffing and Polishing	1436-1441
Caulking Guns & Caulk	1442
Sealants & Hardeners	1443
Headlight Resurfacing Kits	1444
Paint and Supplies	1445-1447
Primers/Rustproofing & Undercoating	1448
Pinstripping Tape	1449
Body Filler & Spreaders	1450-1451

AIR BRUSHES



**IWA4207
Eclipse HC-CS
Airbrush**

- Gravity-feed airbrush, unique 0.35mm needle nozzle combination for fine detail spraying
- High paint flow capacity
- Generous 1/3 oz sized cup, with new funnel shape
- Easy clean up
- Efficient paint flow



**IWA4292
Hi-Line Kustom
HP-TH Airbrush**

- 0.50mm nozzle
- Micro air control
- Teflon needle packings
- Large 1/2 oz. (14cc)removable gravity fluid cup
- Spray gun trigger



**IWAN4500
Gravity Feed
Dual Action
Neo Airbrush**

- Great for beginners
- 0.35 needle nozzle for finer detail, medium spray patterns
- Will hold 1/32 oz. of paint without a cup
- Includes interchangeable large 1/3 oz. and medium 1/16 oz. cups
- Cups are designed with a funnel shape, which makes for easy clean-up and more efficient paint flow



**IWA4200
Eclipse HP-BCS Airbrush**

- Bottom feed airbrush
- 0.5mm needle and nozzle combination
- Varied spray pattern from just one size nozzle and needle
- General purpose, high paint flow airbrushes
- Versatile, reliable performance



**PVE0924
vFan Gravity**

- Usable with solvent or water based paint products
- Standard .9mm detail FAN air cap for perfect coats, as well as a detailed air cap for precision detail to line patterns



**PVE0100
Complete Preval Airbrush Kit**

- Portable with no electricity required
- Ideal for finish touch-ups
- Keeps custom color integrity



Portable, professional, and quiet, the vFan provides professional fan patterns and hairline details with any small job or challenging touch-up. The vFan hose and pressurized can of 150' of ENERGY fit in your pocket and atomize all water- and solvent-based paints.

TITAN



**TIT22958
Mini Air Compressor**

- Great for use with .2mm to 1.0mm air brushes
- Quiet 1/6 HP motor
- Auto start and stop feature for constant air flow
- Includes rubber feet to reduce compressor vibration
- Pressure range: 0-4BAR.
- Includes convenient carry handle

AIR BRUSHES & SPECIALTY SPRAYERS

DEVILBISS®



DEVDGR-501G-35

DAGR™ Gravity Airbrush - .35mm

- Features performance and versatility for the automotive artist
- Hairline detail to high paint-flow shading and gradual fades
- Smooth double action trigger; pre-set handle for precise control of paint flow
- Sprays automotive paints to waterbased inks

BADGER



BAD150-4PK

Professional Head Air Brush Set in Wood Case

Set contains:

- Medium air brush with attachable 3/4oz. (22ml) jar
- Heavy head assembly and needle
- 1/4 oz. (7ml) color cup
- 2 oz. (60ml) jar with cover
- 8' (2.45m) braided air hose
- 1/4" pipe thread fitting (adapts air hose to compressor or CO2 tank)

PRESSURE POTS

Astro



AST2PG85

2 Quart Pressure Pot with Silver Gun and Hose

- 1.7mm nozzle
- Spray gun
- Allows operator to mix and paint 2 quarts (1893cc) at a time
- 6' length fluid hose
- 6' length air hose

 **WARNING:** Cancer and Reproductive Harm - www.P65Warnings.ca.gov

Astro



AST2PG75

2 Quart Pressure Pot with Gun/Hose-1.2M

- 2 Quart Pressure Pot with Gun and Hose, Black Handle, 1.2mm Nozzle
- Set includes: 1 - Spray Gun, 1 - 2 Quart (1893cc) Pressure Cup, 6' Length Fluid Hose, 6' Length Air Hose.

Specifications: Optional Nozzle Size: 2.0mm, Average Air Consumption: 7cfm, Air Inlet Thread NPT: 1/4; Fluid Inlet Thread NPT: 3/8"

 **WARNING:** Cancer and Reproductive Harm - www.P65Warnings.ca.gov

SPRAY GUN KITS



MTNRP8824-A

4 Piece Waterborne H.V.L.P. Spray Gun Kit

- Waterborne spray gun kit (all guns are waterborne compatible)
- Ideal for automotive, furniture and equipment painting
- Gravity-feed design optimizes use of all material, preventing waste
- 1.4mm spray gun is used to apply lighter materials such as base and clear coats
- 1.7mm spray gun is used to apply heavy materials such as primers
- 1.0mm touch up gun is used to apply lighter materials and touch up work
- Lifetime warranty - does not cover abuse.

Kit Contents:

- 1pc- HVLP Spray Gun with 1.4mm Needle and Nozzle Set
- 1pc- HVLP Spray Gun with 1.7mm Needle and Nozzle Set
- 1pc- Touch up Gun with 1.0mm Needle and Nozzle Set
- 1pc- Pressure Regulator with gauge
- 2pcs- Liter Aluminum Cup
- 1pc- 150cc Stainless Steel Cup
- 3pcs- Optional Filter
- 2pcs- Spanner
- 1pc- Socket Spanner
- 1pc- Brush
- 1pc- Aluminum case



DEVILBISS®



DEV802342

StartingLine™ Auto Painting and TouchUp HVLP Spray Gun Set

Includes:

- HVLP spray gun (finish coats) (1.3mm)
- 600cc (20 FL OZ) cup
- HVLP spray gun (detail) (1.0mm)
- 130 cc (4 FL OZ) cup
- Cleaning brush
- Wrench
- Air adjusting valve with gauge

⚠ WARNING: Cancer and Reproductive Harm - www.P65Warnings.ca.gov



DEV802343

StartingLine™ 2 Gun Auto Painting and Priming Kit

- 30 PSI inlet pressure delivers 10 PSI air cap pressure at 13 CFM air volume
- Easy to clean finish and high grade stainless steel parts for durability

Includes:

- HVLP Finish Coat Spray Gun
- 1.3mm Nozzle
- HVLP Primer Spray Gun
- 1.5mm Nozzle
- (2) 600cc 20 oz. Cups
- 1.8mm Nozzle



DEV802789

StartingLine 3 Gun Kit

- StartingLine® by DeVilbiss-A leader in value
- Auto Painting Gun with 1.3mm Fluid Tip
- Auto Painting Gun with 1.8mm Fluid Tip
- Touch-Up Gun with 1.0mm Fluid Tip
- Air Adjusting Valve and Gauge, Cleaning Brush and Wrench
- 6 month warranty on material and workmanship

⚠ WARNING: Cancer and Reproductive Harm - www.P65Warnings.ca.gov

SPRAY GUN KITS

TITAN



TIT19100
3 Piece HVLP Spray Gun Kit
(1.4mm and 1.7mm Needle Nozzle Set)

- One spray gun with a 1.4mm needle and nozzle set for lighter materials such as high quality base coats and clear coats
- A second spray gun with a 1.7mm needle and nozzle set for heavier materials such as primers, surfaces and fillers
- Locking Pressure regulator with gauge
- 1 liter aluminum gravity feed paint cups
- Spray pattern control knob on side of guns
- Air Inlet: 1.4"
- Operating pressure: 15-45 PSI.
- Average Air consumption: 7.0-9.0 CFM
- Lifetime warranty

Replacement parts also available:

- TIT19100-17 - 1.7mm Needle & Nozzle Set
- TIT19100-20 - 2.0mm Needle & Nozzle Set
- TIT19100-25 - 1 Liter Aluminum Paint Cup
- TIT19000-30 - Air Regulator with Gauge



TIT19223
4 Piece HVLP
Dual Set-Up Spray Gun Kit

- Spray gun pattern control allows adjustment from round to full fan shape
- 6" Random orbital sander for paint prep and finishing applications
- Mesh filter for gravity feed paint cups
- Stainless steel needle/nozzle set resists corrosion
- Infinitely adjustable fluid pattern control for precise paint metering
- Lifetime warranty

Kit includes: Gun A: 1.4mm Production Gun, Gun B: 1.7mm Production Gun, 6" Orbital Sander, locking pressure regulator with gauge, 2 spray gun wrenches and cleaning brush.

TITAN



TIT19220
4 Piece Gravity Feed
HVLP Spray Gun Kit

- Aluminum paint cups
- Die cast aluminum body
- 2-Step trigger control
- Non-bleeder type, gravity feed external mix
- Stainless steel nozzles
- Adjustable spray width, air inlet and fluid outlet
- Lifetime warranty

Includes:

- Gun A - 1.0 mm nozzle set for lighter materials and touch up work
- Gun B - 1.4 mm nozzle set for lighter materials
- Gun C - 1.7 mm nozzle set for heavier materials
- Locking pressure regulator with gauge

TIT19911
5 Piece In-Line Filter Screens

- Genuine VAPER® Replacement Part
- Fits all VAPER® Gravity feed spray guns
- In-line mesh filter removes dirt particles from paint to protect against defects
- Insert into gravity feed spray gun fluid inlet prior to cup installation



TIT19221
4 Piece HVLP
Spray Gun Kit
with Aluminum Case

- Includes: 1.0mm Detail Gun, 1.4mm Production Gun, 1.7mm Production Gun
- Locking pressure regulator with gauge
- Aluminum Storage Case
- Lifetime warranty

All guns have: Aluminum paint cups, Die cast aluminum body with chrome plated finish, 2-Step trigger control, Non-bleeder type, gravity feed external mix, Stainless steel nozzles, Adjustable spray width, air inlet and fluid outlet. 1.0 mm nozzle set for lighter materials and touch up work. 1.4mm nozzle set for lighter materials. 1.7mm nozzle set for heavier materials.

THE FUTURE AT SATA STARTS WITH AN



German Engineering

The revolutionary SATAjet X 5500

The Dream Team: Newly designed with synchronized air flow geometry inside the spray gun and nozzle set, ensuring **perfect material distribution, optimized atomization** and **precise spray fan shapes**. All of this combined with **material savings** and a much **softer** application with a **reduced noise level**.

Two distinct available spray fan patterns per nozzle size allows for either enhanced application control or increased application speed, as well as the adaptation of the nozzle set to different temperature and air humidity levels.

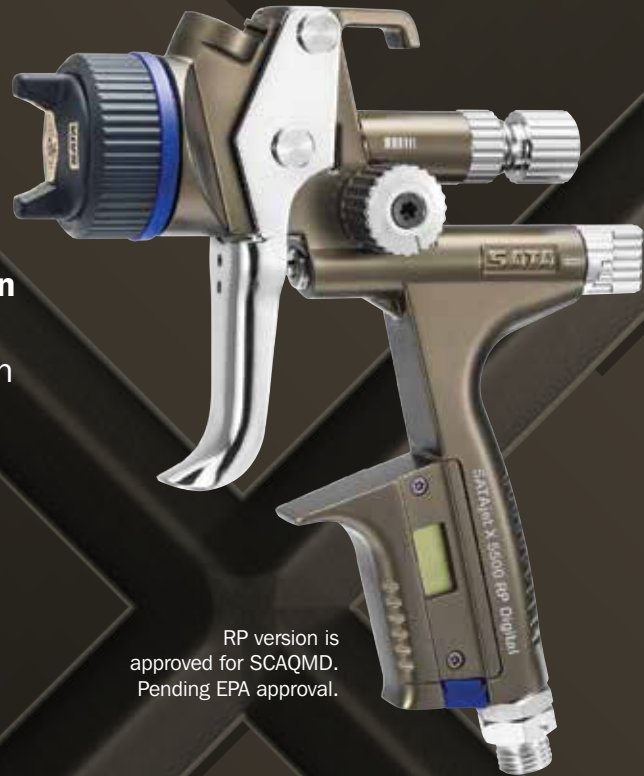

RP version is approved for SCAQMD. Pending EPA approval.

	I-nozzle					O-nozzle				
	RP									
Nozzle size	1.1 I	1.2 I	1.3 I	1.4 I	-	1.1 O	1.2 O	1.3 O	1.4 O	-
Standard with one each RPS multipurpose cup 0.6 l / 0.9 l, with swivel joint										
Part No.	SAT1061548	SAT1061556	SAT1061564	SAT1061572	-	SAT1061580	SAT1061598	SAT1061605	SAT1061613	-
DIGITAL cpl. with one each RPS multipurpose cup 0.6 l / 0.9 l, with swivel joint										
Part No.	SAT1061639	SAT1061655	SAT1061704	SAT1061738	-	SAT1061770	SAT1061796	SAT1061811	SAT1061837	-
	HVLP									
Nozzle size	1.1 I	1.2 I	1.3 I	1.4 I	1.5 I	1.1 O	1.2 O	1.3 O	1.4 O	1.5 O
Standard with one each RPS multipurpose cup 0.6 l / 0.9 l, with swivel joint										
Part No.	SAT1061895	SAT1061902	SAT1061887	SAT1061910	SAT1061928	SAT1061936	SAT1061944	SAT1061952	SAT1061960	SAT1061978
DIGITAL cpl. with one each RPS multipurpose cup 0.6 l / 0.9 l, with swivel joint										
Part No.	SAT1062009	SAT1061986	SAT1062017	SAT1062041	SAT1062059	SAT1062083	SAT1062091	SAT1062132	SAT1062140	SAT1062174

DanAm® The exclusive independent distributor of SATA products in the US and Puerto Rico

www.satausa.com

SATA, SATAjet and/or other SATA products referenced herein are either registered trademarks or trademarks of SATA GmbH & Co. KG in the U.S. and/or other countries.

SPRAY GUNS



Spray Equipment



SAT125666
SATMiniJet® 3000 B HVLP Spray Gun with 1.0 Nozzle Set and .125L Plastic Cup

- Features an incredibly wide, even fan; fan control may be adjusted from either side to allow one hand operation for right or left hand painters
- Built in air micrometer adjusts air pressure and light trigger pull can be operated with one or two fingers
- Especially suitable for spot repair (SR) or complete paint jobs on smaller surfaces
- Because of its compact design, it is quite handy for door jambs or inside small work spaces hard to access

SAT125658
SATMiniJet® 3000 B HVLP Spray Gun with 0.8mm Nozzle Set and .125L Plastic Cup

SAT125765
SATMiniJet® 3000 B HVLP Spray Gun with 1.25R Nozzle Set and .150 Aluminum Cup

- Features an incredibly wide, even fan; fan control may be adjusted from either side to allow one hand operation for right or left hand painters
- Built in air micrometer adjusts air pressure and light trigger pull can be operated with one or two fingers
- Especially suitable for spot repair (SR) or complete paint jobs on smaller surfaces



SAT128496
SATMiniJet® 3000 B HVLP Spray Gun with 1.0SR Nozzle Set and .150 Aluminum Cup

SAT170175
SATAJet® 4000 B HVLP Standard Spray Gun with 1.3mm Nozzle and RPS Cups

- The "Super Saver" SATAJet® 4000 B HVLP achieves particularly high transfer efficiency rates, due to its low pressure technology
- Lightweight, perfect balance and ergonomics
- Extremely quiet-noise level reduced by 50% compared to the SATAJet 3000 B
- Soft, controllable fan for even laydown of material



Spray Equipment



SAT210765
SATAJet® 5000 B HVLP Standard Gun, 1.3 with RPS Cups

- Optimized nozzle concept for highest possible versatility concerning inlet pressure and spray distance
- Pearlchrome™ surface for easy cleaning, corrosion-resistant
- Optimized half-turn spray fan control
- Safely positioned trigger sleeve – for easy, safe and quick insertion of the paint needle
- Identical compact-size gun handle for non-digital and digital spray guns

SAT210799
SATAJet® 5000 B HVLP Standard Gun, 1.4 with RPS Cups

SAT210153
SATAJet® 5000 B RP Digital Gun, 1.2, with RPS Cups

SAT209866
SATAJet® 5000 B RP Standard Gun, 1.2W With RPS Cups

- Optimized nozzle concept for highest possible versatility concerning inlet pressure and spray distance
- Pearlchrome™ surface for easy cleaning, corrosion-resistant
- Optimized half-turn spray fan control
- Safely positioned trigger sleeve – for easy, safe and quick insertion of the paint needle
- Identical compact-size gun handle for non-digital and digital spray guns
- 1 year warranty on material and workmanship



SAT209874
SATAJet® 5000 B RP Standard Gun, 1.3 With RPS Cups

SAT209882
5000B RP Standard Gun, 1.4 With RPS Cups

SAT211136
SATAJet® 5000 B HVLP Dig Gun, 1.3 with RPS Cups

- Optimized nozzle concept for highest possible versatility concerning inlet pressure and spray distance
- Pearlchrome™ surface for easy cleaning, corrosion-resistant
- Optimized half-turn spray fan control
- Safely positioned trigger sleeve – for easy, safe and quick insertion of the paint needle
- Identical compact-size gun handle for non-digital and digital spray guns
- 1 year warranty on material and workmanship



SPRAY GUNS



Spray Equipment



SAT1006833
Limited Edition PHASER
5000B HVLV Std Gun -
1.5 Nozzle w/RPS

- Designed by Porsche Design Studio - Limited Edition design
- Best spray gun available
- Spray gun for special moments
- Redesigned Air Cap for ease in cleaning
- Sampling of RPS cups (three different sizes) will be included, along with lids and strainers



SAT1061944
X5500 HVLV Spray Gun,
1.2 O, w/RPS Cups

- Noticeably more quiet due to Whispering nozzle™ which has optimized air flow geometry
- Low maintenance: there is no air distribution insert, thus ensuring a faster and easier cleaning process
- Oval-shaped spray fan with larger dry zone
- Wet core for increased application speed
- Film build per coat slightly higher
- 1 year warranty on material and workmanship

SAT1061902
X5500 HVLV Spray Gun, 1.2 I, w/RPS Cups

SAT1061952
X5500 HVLV Spray Gun, 1.3 O, w/RPS Cups

SAT1061887
X5500 HVLV Spray Gun, 1.3 I, w/RPS Cups

SAT1061960
X5500 HVLV Spray Gun, 1.4 O, w/RPS Cups

SAT1061910
X5500 HVLV Spray Gun, 1.4 I, w/RPS Cups

SAT1061978
X5500 HVLV Spray Gun, 1.5 O, w/RPS Cups



Spray Equipment



SAT1061986
X5500 HVLV Dig
Spray Gun, 1.2 I, w/RPS Cups

- Noticeably more quiet due to Whispering nozzle™ which has optimized air flow geometry
- Low maintenance: there is no air distribution insert, thus ensuring a faster and easier cleaning process
- Parallel spray fan with minimal dry zone
- Improved control during the coating process
- Reduced film build per coat
- 1 year warranty on material and workmanship

SAT1062132
X5500 HVLV Dig Spray Gun, 1.3 O, w/RPS Cups

SAT1062017
X5500 HVLV Dig Spray Gun, 1.3 I, w/RPS Cups

SAT1062140
X5500 HVLV Dig Spray Gun, 1.4 O, w/RPS Cups

SAT1062041
X5500 HVLV Dig Spray Gun, 1.4 I, w/RPS Cups

SAT1061598
X5500 RP Spray Gun,
1.2 O, w/RPS Cups

- Noticeably more quiet due to Whispering nozzle™ which has optimized air flow geometry
- Low maintenance: there is no air distribution insert, thus ensuring a faster and easier cleaning process
- Oval-shaped spray fan with larger dry zone
- Wet core for increased application speed
- Film build per coat slightly higher
- 1 year warranty on material and workmanship



SAT1061605
X5500 RP Spray Gun, 1.3 O, w/RPS Cups

SAT1061564
X5500 RP Spray Gun, 1.3 I, w/RPS Cups

SAT1061613
X5500 RP Spray Gun, 1.4 O, w/RPS Cups

SAT1061572
X5500 RP Spray Gun, 1.4 I, w/RPS Cups

SPRAY GUNS



Spray Equipment



Spray Equipment



SAT1061796

X5500 RP Dig Spray Gun, 1.2 O, w/RPS Cups

- Noticeably more quiet due to Whispering nozzle™ which has optimized air flow geometry
- Low maintenance: there is no air distribution insert, thus ensuring a faster and easier cleaning process
- Oval-shaped spray fan with larger dry zone
- Wet core for increased application speed
- Film build per coat slightly higher
- 1 year warranty on material and workmanship

SAT1061811

X5500 RP Dig Spray Gun, 1.3 O, w/RPS Cups

SAT1061704

X5500 RP Dig Spray Gun, 1.3 I, w/RPS Cups

SAT1061837

X5500 RP Dig Spray Gun, 1.4 O, w/RPS Cups

SAT1061738

X5500 RP Dig Spray Gun, 1.4 I, w/RPS Cups



SAT203125

SATAjet 100 BF RP Gun, 1.1UV, w/UV RPS Cups

- Primer/Sealer spray guns with low over spray
- Minimal sanding effort
- Extremely smooth material application
- Sturdy air cap thread
- Air micrometer for atomization air adjustment
- Undercoat materials such as primer, sealer, filler and spray putty fulfill an important function within the paint process. Therefore, particular attention must be paid to the application of these materials, using a dedicated primer gun.
- 1 year warranty on material and workmanship



SAT1012666

SATAjet 100 B F RP, 2.0, w/RPS Cups

- Primer/Sealer spray gun with low over spray
- Material flow control with locking nut
- Sturdy air cap thread
- Self-tensioning packings
- Round/flat spray control for single-hand operation

SAT1012658

SATAjet 100 B F RP, 1.8, w/RPS Cups

SAT1012640

SATAjet 100 B F RP, 1.6, w/RPS Cups

SAT1012632

SATAjet 100 B F RP, 1.4, w/RPS Cups

SAT1012707

SATAjet 100 B F HVLP, 2.1, w/RPS Cups

SAT1012690

SATAjet 100 B F HVLP, 1.9, w/RPS Cups

SAT1012682

SATAjet 100 B F HVLP, 1.7, w/RPS Cups

SAT1012674

SATAjet 100 B F HVLP, 1.4, w/RPS Cups

SPRAY GUNS



Spray Equipment

SAT146191
SATAjet 100™ BF Super Saver
HVLP Primer Spray Gun
with 1.7mm Nozzle
and 1.0L Aluminum Cup

- Only 7 – 29 psi inlet pressure
- Extremely smooth material application
- Minimizes sanding
- Fine material atomization with a wide fan pattern
- Lightweight ergonomic design



SAT146399
SATAjet 100™ BF Super Saver HVLP Primer
Spray Gun with 1.4mm Nozzle and 1.0L Aluminum Cup



SAT1065136
Minijet 4400B RP Gun, 1.3SR w/RPS Cups

- For small surfaces and areas of difficult access
- QCC for all RPS cup sizes
- Corrosion-resistant chrome surface
- Easy cleaning and maintenance
- 1 year warranty on material and workmanship



SAT166934
Nozzle Set for SATAjet 4000 B HVLP Spray Gun, 1.2



Spray Equipment



SAT166942
Nozzle Set for SATAjet 4000 B HVLP Paint Gun - 1.3

- For use with any waterborne materials
- For use with any solvent borne materials
- Nozzle set comes with air cap, fluid tip, and needle



Spray Equipment

SAT198366
SATAminijet® 4400 B HVLP
Paint Spray Gun

- For small surfaces and areas of difficult access
- Special SR nozzle sets for the smallest spot repairs
- New ergonomically shaped handle
- Cup connection for quick and clean cup changes as well as easy cleaning
- VOC-compliant atomization technology



SAT198176
SATAminijet® 4400 B HVLP
Paint Spray Gun

- For small surfaces and areas of difficult access
- Special SR nozzle sets for the smallest spot repairs
- New ergonomically shaped handle
- Cup connection for quick and clean cup changes as well as easy cleaning
- VOC-compliant atomization technology



SAT209858
SATAjet® 5000B RP Standard Gun,
1.2 with RPS Cups

- Optimized nozzle concept for highest possible versatility concerning inlet pressure and spray distance
- Pearlchrome™ surface for easy cleaning, corrosion-resistant
- Optimized half-turn spray fan control
- Safely positioned trigger sleeve – for easy, safe and quick insertion of the paint needle
- Identical compact-size gun handle for non-digital and digital spray guns



Part Number	Gun Type	Nozzle Size/Type
SAT170167	Standard	WSB Nozzle
SAT170159	Standard	1.2mm Nozzle
SAT170183	Standard	1.3mm C Nozzle
SAT170209	Standard	1.4mm Nozzle
SAT170217	Standard	1.4mm HC Nozzle
SAT170696	Standard	1.5mm Nozzle
SAT170365	Digital	1.3mm Nozzle
SAT170373	Digital	1.3mm C Nozzle
SAT170399	Digital	1.4mm Nozzle
SAT169979	Standard	1.2mm Nozzle
SAT169995	Standard	1.3mm Nozzle
SAT170035	Digital	1.3mm Nozzle

SPRAY GUNS



SAT1057323

Tool Kit

- This tool set is genuine SATA for the SATAjet X 5500
- Includes SATA Spanner Wrench, T handle tool to remove battery cover, air piston packing holder, fluid packings and air micrometer, 4 pack of Color Code System (CCS) tabs to easily identify your spray gun
- 1 year warranty on material and workmanship



DEVILBISS®

DEV703566

TEKNA® ProLite Spray Gun with Aluminum Cup (1.2, 1.3, 1.4 Nozzles; TE10, TE20 Air Caps)

- TEKNA® ProLite - Any Climate, optimized performance in climates varying from hot and humid to cold and dry
- Any Paint, excellent for solvent-based coatings and a must for waterborne
- Includes 900cc Aluminum Cup, packaged as a solution with multiple components allowing the painter to adapt to changing environments
- Fully coated both inside and out with amazing QuickClean™ coating which has non-stick properties
- TEKNA® ProLite spray gun is well-balanced and ergonomically designed for increased comfort and performance

WARNING: Cancer and Reproductive Harm - www.P65Warnings.ca.gov



DEV703517

TEKNA® ProLite Spray Gun, Uncupped with 1.3, 1.4 Needle TE20, HV30

- Engineered for all climate performance
- Well balanced and ergonomically designed for increased comfort and performance
- Fully coated inside and outside with amazing QuickClean™ non stick coating
- Unique "no-kick" co-axial air valve make blends and fades easier
- Packaged as a solution with multiple components allowing the painter to adapt to changing environments

WARNING: Cancer and Reproductive Harm - www.P65Warnings.ca.gov



DEV802405

Starting Line Spot Repair Gun

- StartingLine Detail and Touch-Up HVLP Gravity Spray Gun
- Includes 1 Year Limited Warranty
- 1 Mini-Size Touch-Up STARTINGLINE HVLP Gravity Feed Spray Gun with a 1.0mm Fluid Tip and a 8.5 oz Me

WARNING: Cancer and Reproductive Harm - www.P65Warnings.ca.gov



DEVILBISS®

DEVGFG-670

Gravity Feed Spray Gun with 1.2, 1.3 and 1.4mm Tips

- 32 oz aluminum cup with push on lid
- Air adjusting valve with gauge
- Spray lube, fluid filter, gun hook

Specifications:

- Air consumption: 9 cfm at 30 psi inlet pressure
- Air cap pressure exceeds 10 psi
- High solids clear coat gun of choice Precision engineered #410 air cap lays out a smooth, high gloss finish
- High speed coverage saves time-20% larger spray pattern and 15% more fluid flow than traditional air spray or reduced pressure guns due to new air cap and tip design
- High transfer efficiency-Greater than 65% transfer efficiency saves material and improves visibility
- Easy to clean-Plated gun body is gun washer safe and maintains its "like new" appearance



DEV703661

Tekna® Copper Gravity Feed Spray Gun with 1.3 and 1.4 Needle

- Cup Type: uncupped includes adapter
- Slicker clears, superior metallic control, better blends
- High transfer efficiency - saves materials, saves money
- Digital gauge for accuracy and repeatability
- Waterborne compatible
- 1 year warranty on material and workmanship

WARNING: Cancer and Reproductive Harm - www.P65Warnings.ca.gov



SPRAY GUNS

DEVILBISS®

DEV703675

Tekna® Copper Gravity Feed Spray Gun with 1.2 and 1.3 Needle

- Cup Type: uncupped includes adapter
- Slicker clears, superior metallic control, better blends
- High transfer efficiency - saves materials, saves money
- Digital gauge for accuracy and repeatability
- Waterborne compatible



Includes: 7E7 high Efficiency Air Cap, Digital Gauge with Air Adjusting Valve (HAV-555), Gun Wrench, and Color ID Rings

⚠ WARNING: Cancer and Reproductive Harm - www.P65Warnings.ca.gov

DEV703662

Tekna® Copper Gravity Feed Spray Gun with 1.3 and 1.4 Needle

- Cup Type: 900 cc Aluminum
- Slicker clears, superior metallic control, better blends
- High transfer efficiency - saves materials, saves money
- Digital gauge for accuracy and repeatability
- Waterborne compatible
- Versatility: waterborne basecoats (all climates), solvent basecoats (all brands) and clearcoats (high, medium and low solids)



Includes: 7E7 high Efficiency Air Cap, Digital Gauge with Air Adjusting Valve (HAV-555), Gun Wrench, and Color ID Rings

⚠ WARNING: Cancer and Reproductive Harm - www.P65Warnings.ca.gov

DEVFLG-671

FinishLine® Waterborne Spray Gun Value Kit

- Enhanced atomization technology for the latest coatings
- Includes multiple fluid tips (HVLP 1.3, 1.5, 1.8), 20 oz. Acetal cup, and air adjusting valve with gauge
- Waterborne compatible, anodized internal passages, easy to clean anodized finish
- High grade stainless steel components
- Applications: waterborne base coats, top coats, and light primers



Made in U.S.A.



DEVFLG-670

FinishLine® Solvent-Based Spray Gun Value Kit

- Enhanced atomization technology for the latest coatings
- Includes multiple fluid tips (HVLP 1.3, 1.5, 1.8), 900 cc aluminum cup and air adjusting valve with gauge
- HVLP high transfer efficiency
- Waterborne compatible, anodized internal passages, easy to clean, high grade stainless steel components
- Applications: solvent base coats, top coats, and light primers



Made in U.S.A.



DEVILBISS®

GTI



Made in U.S.A.

DEVGTI-620G

Gravity Feed HVLP Paint Gun with 1.3, 1.4, 1.5mm Tips and Aluminum Cup

- 25% larger spray pattern for fast coverage
- Even distribution of metallic for no mottling or striping
- Excellent color matching capabilities



GTI Millennium HVLP Spray Gun includes: 1.3mm, 1.4mm and 1.5mm fluid tips (introductory offer), 32 oz aluminum cup (120175/GFC502) with push on lid, air adjusting valve with gauge (18003/HAV-501), spray lube, fluid filter and gun hook

DEV703567

TEKNA ProLite Spray Gun, Uncupped 1.2, 1.3, 1.4 Needle TE10, TE20

- Engineered for all climate performance
- Well balanced and ergonomically designed for increased comfort and performance
- Fully coated inside and outside with amazing QuickClean™ non stick coating
- Unique “no-kick” co-axial air valve make blends and fades easier



Includes disposable cup adapter for use with disposable cup systems.

⚠ WARNING: Cancer and Reproductive Harm - www.P65Warnings.ca.gov

TEKNA Primer Guns/Cups

- TEKNA® Primer is the ultimate in primer spray gun technology
- Large spray patterns
- Even material distribution
- Suitable for all types of primers, surface coating, fillers and polyesters
- Balanced air valve design for easier trigger pull and improved air flow
- PR10 High Efficiency Air Cap
- PR30 HVLP Air Cap
- 900cc aluminum cup
- Gun wrench
- Color ID rings

DEV704174 - (1.4, 1.6, PR10, PR30)

- 1.4 and 1.6 fluid tips

DEV704175 - (1.8, 2.0, PR10, PR30)

- 1.8 and 2.0 fluid tips

DEV704182 - (2.5, PR10, PR30)

- 2.5 fluid tips

⚠ WARNING: Cancer and Reproductive Harm - www.P65Warnings.ca.gov



SPRAY GUNS

DEVILBISS®



**DEV704198
TEKNA Clearcoat Gun
(1.2, 1.3, 1.4, TE25, HV30)**

- Superior atomization reduces texture
- Improved spray pattern for even material distribution
- Uniform atomization for ease of application
- Suitable for all types of clearcoats
- Higher transfer efficiency

The TEKNA Clearcoat delivers superior atomization with a straight sided pattern, improving comfort and ease of use. Clearcoats wet out easier, improving texture and gloss retention while saving materials.

DEVILBISS®



**DEVJGA-644
Spray Gun Suction 1.6mm Fluid Tip
with Cap and Cup**

- World famous JGA fit, feel, and balance
- Superior atomization - Newest 9000 air cap designed for today's refinishing materials
- Provides uniform film build for maximum control of brightness with metallics
- Stainless steel fluid tip and needle
- Maximum durability - drop-forged aluminum gun body

Replaceable threaded baffle for economical servicing. Cartridge type air valve for positive sealing and quick action. Includes: TGC one-quart suction feed cup.

ANEST IWATA

**IWA4758
W400LV-134G Compliant Spray
Gun with 1000ml Cup**

- LV technology for less overspray and more material in pattern
- Less material use than competitors guns
- Low air consumption
- Superior atomization
- Excellent in waterborne applications



**IWA4763
W400LV-144G Spray Gun
with 1000ml Cup**

- 1.4 nozzle size
- LV technology for more material in pattern and less overspray
- Applicable in solvent and waterborne
- Superior Atomization
- Compliant to HVLP standards
- Center post, gravity fed



**IWA5276
W400LV-144G Spray Gun
with 1000ml Cup**

- Miniature spray gun adaptable to small touch up work or custom painting
- Spray pattern can open to 3.9"
- Side mounted cup for easy viewing of target
- Low air consumption, operates on 1.8 CFM
- Superior atomization



ANEST IWATA

**IWA5552
LPH400-144LV Center Post
Gravity Feed HVLP Spray Gun
with 700ml Aluminum Cup**

- LV Technology for fine atomization and less overspray
- Low air consumption, operates on 9.5 CFM
- Superior atomization
- Applicable in solvent or waterborne products
- Designed for Base and Clear coat, single stage products



**IWA5553
LPH400-144LV Center Post Gravity Feed
HVLP Spray Gun with 1000ml Aluminum Cup**

**IWA5550
LPH400-144LV Center Post Gravity Feed
HVLP Spray Gun**

**IWA5662
LPH400-134LVX eXtreme Basecoat Spray Gun
with 700 ml Cup**

- LV technology for a 11.8" tulip pattern thus more material in pattern and less overspray
- Applicable in solvent or waterborne products
- Low air consumption
- Superior atomization
- Center post gravity HVLP spray gun

**IWA5663
LPH400-134LVX eXtreme Basecoat
Spray Gun with 1000ml Cup**

**IWA5660
LPH400-134LVX eXtreme Basecoat Spray Gun**



SPRAY GUNS



IWA5643
LPH400-134LV Spray Gun
with 1000ml Cup

- LV technology provides a 11.0 in pattern with less overspray and more material in the pattern
- Low air consumption
- Superior atomization
- Applicable in solvent and waterborne products
- Center post gravity fed HVLP spray gun
- 1 year warranty on material and workmanship

IWA5642
LPH400-134LV Spray Gun with 700ml Cup



IWA5935
LS400-1305 Entech Spray Gun
With HVLP Technology

- Excellent for solvent or waterborne applications
- Large fan pattern
- HVLP Technology
- Concentrated Coarse Atomization
- Superior transfer efficiency
- 1 year warranty on material and workmanship



IWA9233
AZ3HV2-20GC HVLP
Spray Gun with 2.0 Nozzle

- Redesigned performance
- Low cost affordable spray gun
- New ergonomic lighter body
- Soft trigger pull to reduce fatigue
- New polished surface for easier clean up
- 1 year warranty on material and workmanship



IWA5905
WS400-1301HD Spray Gun

- EPA 6H Compliant
- Large uniform tulip spray pattern
- Very Fine Atomization
- Standard for clear coats
- Superior transfer efficiency
- 1 year warranty on material and workmanship



IWA5938
LS400 Entech 1.3 w/1000mi Cup

- HVLP technology - 10PSI at the nozzle
- Concentrated coarse atomization
- Excellent for solvent or waterborne base coat application
- Large fan pattern
- Superior transfer efficiency
- Warranty - Repair only up to 1 year



IWA5940
SUPERNOVA Entech
1.4 Nozzle, Gun Only

- Painting, blending and color matching are made easier with better transfer efficiency by concentrating
- Entech technology is best for water, solvent and compliant basecoat products
- Split tip technology is evolving and continues to be the preferred choice for painters and pain companies
- Fan is dense, flat and atomization is dispersed evenly throughout the pattern
- Air caps larger thread pattern makes it both robust and easy to remove and is designed with low maintenance in mind
- Warranty - Repair only up to 1 year

SPRAY GUNS



IWA9230
AZ3HV2-13GC HVLV Spray Gun with 1.3 Nozzle

- Redesigned performance
- Low cost affordable spray gun
- New ergonomic lighter body
- Soft trigger pull to reduce fatigue
- Polished surface for easier clean up

An affordable center post gravity HVLV spray gun. Pattern width: 11.0"; 28 PSI; 12.0 cfm; Usage: sealer.

IWA9231
AZ3HV2-15GC HVLV Spray Gun with 1.5 Nozzle

- Usage: sealer

IWA9232
AZ3HV2-18GC HVLV Spray Gun with 1.8 Nozzle

- Usage: primer



SHA28879
Finex™ FX3000 Gravity Feed HVLV Spray Gun with 1.3mm Nozzle

- A full size HVLV gun with large fan pattern, up to 12.5"
- Includes 600cc aluminum cup, wrench and cleaning brush
- Black Nickel finish
- 1 year warranty

SHA28880
Finex™ FX3000 HVLV Spray Gun with 1.4mm Nozzle
Applications: base coat, clear coat, single stage, sealers low solid clear.

SHA28882
Finex™ FX3000 Gravity Feed HVLV Spray Gun with 1.8mm Nozzle



SHA289200
Finex™ FX1000 Mini-HVLV Spray Gun with 1.0mm Nozzle

- Two finger control for anti-fatigue painting in confined access areas like doorjamb or for detailed touch-up work
- Large pattern size, up to 9"
- Includes FX1000 gun, 125cc cup, wrench and cleaning brush
- Comes with 1 year warranty

SHA289222
Finex™ FX1000 Mini-HVLV Spray Gun with 1.4mm Nozzle

Applications: clear and base coats, single stage, sealers, low solid clear, general purpose.

SHA28885
Finex™ FX2000 Gravity Feed Conventional Spray Gun with 1.4mm Nozzle

- Large pattern size, up to 12"
- 1.4 nozzle recommended usage: base coat, clear coat single stages, sealers, low solid clear, clear coat
- Includes FX2000 gun, 600cc aluminum cup, wrench and cleaning brush
- Includes one year warranty
- Repair kits available



SHA28887
Finex™ FX2000 Gravity Feed Conventional Spray Gun with 1.8mm Nozzle



TIT19418
Siphon Feed Production Spray Gun

- Fully adjustable spray pattern
- 1.8 mm needle and nozzle set for heavier materials
- Non bleeder type, siphon feed
- External mix for fine atomization
- Spun aluminum 1 liter cannister

SPRAY GUNS

TITAN

VAPER

TIT19000 Gravity Feed HVLP Spray Gun with 1.4mm

- Blue body
- Locking pressure regulator with gauge
- Stainless steel needle
- 600cc plastic paint cup



TIT19018 Gravity Feed HVLP Spray Gun with 1.8mm

- Red body
- Locking pressure regulator with gauge
- Stainless steel needle
- 600cc plastic paint cup



TIT19023 Gravity Feed HVLP Spray Gun with 2.3mm

- Green body
- Brass Fluid and Air Nozzle
- 600cc Plastic Cup



TIT19110 HVLP Touch Up Spray Gun with 1.0mm

- 100 cc Aluminum paint cup
- Ships in reusable storage tray
- Includes cleaning kit with maintenance tools



Astro

AST4008 Gun 1.8mm Siphon Feed Primer with 1 Qt. Aluminum Cup

- All-purpose easy-to-clean paint spray gun
- Two-piece construction with gun featuring exclusive air valve design
- Fully adjustable wide fan pattern control
- 1 quart capacity dripless cup

Specifications:

- Nozzle Size: 1.8mm
- Operation Pressure: 50-60psi
- Net Weight: 3lbs./1.36kg
- Average Air Consumption: 7-12cfm
- Air Inlet Thread NPT: 1/4"
- Required Compressor: 3hp
- Max. Pattern at 8" Distance: 11"/280mm

WARNING: Cancer and Reproductive Harm - www.P65Warnings.ca.gov



Astro

ASTEUROHV103 EuroPro Forged HVLP Spray Gun with 1.3mm Nozzle and Plastic Cup

- Durable and lightweight
- Over 65% transfer efficiency
- Quick thread technology
- Smooth operation
- Stainless steel needle and fluid tip



Forged body provides longer tool life. Anodized body for corrosion protection. Slick finish for faster and easier cleaning. Internal coated passages. Unique pattern designed for great coverage, optimal overlapping.

WARNING: Cancer and Reproductive Harm - www.P65Warnings.ca.gov

ASTEUROHV105 EuroPro Forged HVLP Spray Gun with 1.5 Nozzle and Plastic Cup

ASTEUROHV107 EuroPro Forged HVLP Spray Gun with 1.7mm and Plastic Cup

WARNING: Cancer and Reproductive Harm - www.P65Warnings.ca.gov

MOUNTAIN



MTN4118 1.8mm HVLP Siphon Feed Spray Gun

- HVLP (High volume low pressure) spray gun make the spraying softer, easily controlled and less overspray
- Includes adjustable fluid, pattern and air controls
- Stainless steel needle and nozzle accommodate a variety of coatings
- 1000ml aluminum syphon feed paint cup
- Precise air cap set

Adjustable flow rate and spray pattern of 6.5"-8". Applicable in waterborne products.

Ergonomic design provides comfortable grip. Working pressure: 36-50 psi. 1/4" NPS air inlet

WARNING: Cancer and Reproductive Harm - www.P65Warnings.ca.gov

SPRAY GUNS



WARNING: Cancer and Reproductive Harm - www.P65Warnings.ca.gov



MTN4117
1.4mm HVLP
Gravity Feed Spray Gun

- HVLP (High volume low pressure) spray gun make the spraying softer, easily controlled and less overspray
- Includes adjustable fluid, pattern and air controls
- Stainless steel needle and nozzle accommodate a variety of coatings
- Large 1000ml, chemical-resistant aluminum paint cup
- Precise air cap set

Adjustable flow rate and spray pattern of 7"-10". Applicable in waterborne products. Ergonomic design for comfortable grip. Working pressure: 29-50 psi. 1/4" NPS air inlet.



WARNING: Cancer and Reproductive Harm - www.P65Warnings.ca.gov



MTN4110
1.0mm Mini HVLP
Touch-Up Spray Gun

- Perfect for detail, touch-up and small jobs
- HVLP (High volume low pressure) spray gun make the spraying softer, easily controlled and with less overspray
- Includes adjustable fluid, pattern and air controls
- Stainless steel needle and nozzle accommodate a variety of coatings
- 125ml chemical-resistant stainless steel paint cup

Other features include: precise air cap set; adjustable flow rate and spray pattern of 4" - 6.5"; working pressure of 29-50 psi. 1/4" NPS air inlet. Applicable in waterborne products.



WARNING: Cancer and Reproductive Harm - www.P65Warnings.ca.gov

KTI80995
Deluxe Spray Gun with Cup

- This deluxe spray gun features a siphon feed, external mix, built-in regulator and drippless cup. Gun works with all types of automotive refinishing materials.

KTI89194
Spray Gun Filter 2 Pack



ALUMINUM CUPS



- SAT96685**
QCC 1.0L Aluminum Cup
- Includes QCC (quick cup coupler)



- SHA6610**
No Drip Siphon Feed
1 Quart Paint Gun Cup



- TIT19906**
1000 ml Aluminum
Gravity Feed Paint Cup
- Genuine VAPER® Replacement Part
 - Fits VAPER 19100 and 19200 Series gravity feed production spray guns
 - Includes snug fitting press fit lid

PLASTIC CUPS



Spray Equipment

- Easy to use – only 3 parts
- Fits directly all SATA spray guns - no adapters required
- Constant, even material flow, helping the painter to achieve perfect finishing results
- Allows very quick color changes

SATA RPS (Rapid Preparation System) is the ideal cup system for shops focusing on perfect finishes and high profitability. It makes a painter's life much easier, considerably increases productivity and drastically reduces the consumption of cleaning solutions and solvents.



Part Number	Cup Type	Cup Size	Lid Type	Sieve Size	Quantity
SAT1010420	RPS Cup	0.3L	Std Lid	125m Flat Sieve	Qty 100
SAT1010404	RPS Cup	0.3L	Std Lid	200m Plug-In Sieve	Qty 100
SAT1010561	RPS Cup	0.3L	Mini Lid	200m Plug-In Sieve	Qty 60
SAT1010553	RPS Cup	0.3L	Mini Lid	125m Flat Sieve	Qty 60
SAT1012004	RPS Cup	0.9L	Std Lid	200m Flat Sieve	Qty 40
SAT1011981	RPS Cup	0.9L	Std Lid	200m Plug-In Sieve	Qty 40
SAT1011973	RPS Cup	0.9L	Std Lid	125m Flat Sieve	Qty 40
SAT1010397	RPS Cup	0.3L	Std Lid	200m Plug-In Sieve	Qty 40
SAT1010545	RPS Cup	0.6L	Std Lid	200m Flat Sieve	Qty 60
SAT1010503	RPS Cup	UV 0.6L	Std Lid	200m Plug-In Sieve	Qty 60
SAT1010496	RPS Cup	UV, 0.6L	Std Lid	125m Flat Sieve	Qty 60
SAT1010488	RPS Cup	0.6L	Std Lid	200m Plug-In Sieve	Qty 60
SAT1010438	RPS Cup	0.6L	Std Lid	125m Flat Sieve	Qty 60
SAT1010389	RPS Cup	0.3L	Std Lid	125m Flat Sieve	Qty 40



Spray Equipment

SAT27243
 .6 Liter QCC Plastic
 (PVC) Gravity Cup



SHA289320
 20 Oz. Finex Aluminum
 Gravity Feed Cup

- Fits all Finex 1000/2000/3000 Series guns
- Replacement plastic lid: PN289818



TIT19900
 Replacement Plastic
 Paint Cup, 600 ml,
 for 19000 Series Paint
 Spray Guns



DEVDP-607
 DeKups® Reusable Cup Frame
 and Lid - 9 oz.

- Use with the DEVDP-602 disposable cups and lids



DEVDP-606
 DeKups® Reusable Cup Frame
 and Lid - 24 oz.

- Positive locking lid
- Refill without opening the cup
- 1 frame and lid per package
- Use with the DEVDP-601 disposable cups and lids



DEVDP-601
 Disposable
 Cups Lids

- Liners and lids are used inside a reusable cup frame for convenient, time saving paint applications
- Disposable cup liners easily collapse during painting resulting in less left-over paint
- 32 cups and lids per packaging
- Cups and lids come in packaging that acts as the dispenser allowing a painter to conveniently dispense one cup and liner at a time
- Use with the DEVDP-604 reusable cup frame and lid set



REGULATORS



Spray Equipment

SAT27771

Regulator With Gauge

- For precise air pressure setting
- Perfect for guns without digital readout



MTN6182

Air Regulator with Gauge

- Includes a 0 to 160 psi pressure gauge
- Provides fine air control for spray guns & air tools
- Swivel top allows for easy installation
- Infinite adjusting range fits any spray gun or air tool inlet
- Air outlet: 1/4" NPT

WARNING: Cancer and Reproductive Harm - www.P65Warnings.ca.gov



MTN6183

Air Regulator for Devilbiss Paint Guns

- Made for Devilbiss paint guns
- Easy installation - 5/16" thread size
- Includes 0 to 160 psi pressure gauge
- 1 year limited warranty

WARNING: Cancer and Reproductive Harm - www.P65Warnings.ca.gov



KT189191

1/4" Air Regulator

KT189193

Air Regulator 1/4" with Gauge

WARNING: Cancer and Reproductive Harm - www.P65Warnings.ca.gov



IWA8130B

Compact Air Flow Control Valve

- Compact design
- EPA compliant gauge to 40 cfr standard
- Consistent air flow
- Non-slip control knob
- Easy to read gauge
- The new 8130B control valve, has an easy to ready EPA compliant gauge, and a non-slip control knob to provide constant air flow.



SHA3310

Air Adjusting Regulator with Gauge 0 to 160 psi 36AAV-HV

- Especially designed for HVLP, high volume air adjusting valve
- Includes pressure gauge that reads up to 160 psi
- Air inlet: 1/4" npsm



SHA1410

Mini Air Regulator with Gauge

- This small, lightweight unit attaches to any spray gun, including HVLP, for accurate air pressure regulation
- It is a true diaphragm regulator with push/pull lock pressure setting and easy to read 0 to 160 psi gauge
- Air flow capacity: 22 cfm



SHA1010

1/4" 12AAV Adjusting Air Regulator

- Precision tapered valve
- Full open to close with approximately 4 turns
- Infinitely adjustable
- Large, easy to handle knob
- Air inlet: 1/4" M.P.T.
- Air outlet: 1/4" F.P.T. (swivel nut)



SHA2210

Air Adjusting Regulator with Gauge 0 to 160psi 24AAV

- Same quality features as the model 12AAV
- Includes pressure gauge that reads up to 160 psi
- Fits all leading spray guns
- Can be used on HVLP spray guns
- Air inlet: 1/4" M.P.T.
- Air outlet: 1/4" F.P.T. (swivel nut)



SHA1630

Model 18C-3R Air Regulator

- 3 Regulated outlets
- Air Inlet 3/8" F.P.T.
- All outlets 1/4" F.P.T.
- Capacity 50 CFM



SHA1640

18C-500 Air Regulator Assembly

- Three regulated outlets, one main line outlet (bypass)
- Includes air gauge (GA-160) and 1-HC-1885 air cock (1/4" M.P.T.)
- Capacity 50 CFM



GUN HOLDERS

AP Astro

ASTGFH1000 2 Piece Construction Gravity Feed Paint Gun Holder

- Works great with all gravity feed guns
- Top strainer holder may be removed for additional clearance
- Strainer holder swivels away from cup

WARNING: Cancer and Reproductive Harm - www.P65Warnings.ca.gov



TITAN

Magnetic Spray Gun Holders

- Provides storage of gravity feed spray guns when not in use
- Attaches to spray walls, work stations, tool boxes, or any metal surface
- Vinyl coated hooks protect spray gun finish from scratches
- Lifetime warranty
- Spray gun not included

TIT19991 Magnetic Spray Gun Holder



TIT19990 Magnetic Spray Gun Holder



LTI900 Magnetic Spray Gun Holder

- Holds any cup or gravity fed spray gun without creating holes in your spray booth
- The tubular design mounts to any flat steel surface with a 160 lb. magnetic force

ACCESSORIES



KTI80989 Paint Spray Gun Cleaning Kit

Assorted brushes and tools, safe to use with solvents

WARNING: Cancer and Reproductive Harm - www.P65Warnings.ca.gov



3M

MMM16565 3M™ Accuspray™ AAH Air Cap Tester

- Air cap tester to be used with the 3M™ Accuspray™ Spray Gun family
- For testing HVLP compliance
- HVLP compliance on air caps that contain an auxiliary air hole (AAH)



SGT17000 Brush Set for Spray Gun Orifices

- For cleaning the small air passages on air caps and fluid tips
- 5 brushes with the following diameters: .0625", .094", .125", .156" and .187".

WARNING: Cancer and Reproductive Harm - www.P65Warnings.ca.gov

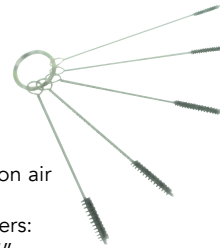

AP Astro

AST4544 Master Spray Gun Cleaning Kit

Kit includes:

- 7 Pc. micro needle set with handle
- 2 Pc. end brush set with handle
- Power brass pick-up tube brush
- 1/4" nylon HVLP brush
- 5 Pc. precision mini brush set with split ring holder
- 12" pick up tube brush
- Suggest tapered brush
- Nylon GP brush

WARNING: Cancer and Reproductive Harm - www.P65Warnings.ca.gov



SGT17280 Spray Gun Cleaning Kit

- Kit contains all necessary brushes and tools to effectively clean spray guns including new HVLP paint spray guns
- Also cleans gravity feed, siphon and undercoating guns
- Special pick probe is provided for cleaning air caps
- Safe to use with chemicals and solvents

WARNING: Cancer and Reproductive Harm - www.P65Warnings.ca.gov

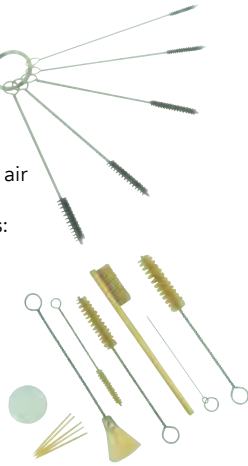

AIR FILTRATION

ARROW DRYERS



ARRPD1204XL

PneuMasterAir 2 Quart Desiccant Dryer

- Lowers the dew point to -30° F
- Includes 2 quarts of desiccant beads made of silica
- Sight glass indicates color change
- Built in after-filter prevents down stream dust
- The unit is rated for 25 SCFM

This 2 quart desiccant dryer/filter removes all water vapor by lowering the dew point to -30° F. When the beads change from blue to pink, it is time to change the beads. The unit includes two quarts of desiccant.



ARRPMA-10

PneuMasterAir Mini Disposable Desiccant Dryer

- Ideal for paint spray guns
- Lightweight unit, 1/4" NPTs can be used in either direction
- Removes dirt, oil, water vapor, and desiccant dust
- Desiccant beads lower the dew point to -30° F
- Replace when desiccant beads turn from blue to pink
- Attach this unit directly to a spray gun or mini regulator located at the gun. Sintered bronze elements remove particulate down to 40 micron as oil removing media removes oil vapors. Rated at 15 SCFM and 125 PSI.

WARNING: Cancer and Reproductive Harm - www.P65Warnings.ca.gov

ARRPC7612XXL PneuMasterAir 5 Stage Desiccant Filter/Dryer

- 5 Stage filtration
- Easy to fill bowl



Five stage filtration includes: 1) 40 micron filter with 9oz metal bowl with sight glass. 2) .01 micron coalescing filter with 9oz metal bowl with sight glass and pop-up indicator. 3) one gallon desiccant dryer that lowers the dew point to -30° F. 4) 3 micron filter with 9oz metal bowl with sight glass to protect from desiccant dusting. 5) 5-125psi regulator with three position adjusting knob. The unit includes gauge, shut off valve and one gallon of desiccant.



KT189194

Spray Gun Filter 2 Pack

WARNING: Cancer and Reproductive Harm - www.P65Warnings.ca.gov



DEVHAF507

Disposable In-Line Filter

- Excellent filtering capabilities
- Strongest thread and housing design and highest solvent resistance of any disposable filter on the market
- 125 psi, max operating pressure

DEV130504

Desiccant Cartridge

- CT series desiccant air dryers remove water vapor from the compressed air down to a dew point of -40 degrees F
- Quick change 10 lb. desiccant cartridge bag is made of a special fiber media which removes oil aerosols and solid particles down to .01 microns - meaning no need for coalescing or final filters
- Install at point of use



MIL1020

1/2" Micro Filter

- Supplied with pre-assembled automatic overnight drain
- Porous bronze 40 micron filter element allows less pressure drop and longer cleaning intervals
- Polycarbonate bowl with Safety metal bowl guard

WARNING: Cancer and Reproductive Harm - www.P65Warnings.ca.gov

MIL1019

3/8" Micro Filter

WARNING: Cancer and Reproductive Harm - www.P65Warnings.ca.gov

MILS1173

Mini Disposable Air Line Desiccant Filter/Dryer

- Removes all traces of dirt, dust, water vapor, oil vapor
- Unit ideal for spray guns and applications requiring clean supply of air
- 3-3/4" x 1-1/2" size, lightweight at 2 oz.
- Male and female 1/4" NPT ports
- See through, non-metallic chemical resistant material
- Maximum working pressure: 125 PSI. Maximum flow capacity: 15 SCFM; working temperature: 32° F to 130° F.



AIR FILTRATION



SHA6760

Dryaire Desiccant System

- Remove dirt, water, oil and uncondensed moisture from compressed air lines
- The Dryaire Desiccant System's 100% indicating silica gel provides maximum moisture absorption
- Features easy desiccant changeout, regenerate, or replacement and changes color when saturated

SHA6730

606B Air Control Unit

- Effective at removing water, oil and contamination to protect air cylinders and air tools
- Contains 18C-3R regulator with a 160 lb. inverted gauge and air cock
- Regulated outlet and filtered main line outlet with 200 lb. gauge included
- 5 micron filtration
- Filter capacity: 120 cfm; regulator capacity: 50 cfm



SHA6720

120 CFM/50 CFM 1/2" Inlet Air Filter/Regulator

- Air Inlet: 1/2" F.P.T.
- Filter Capacity: 120 CFM
- Regulator Capacity: 50 CFM

SHA6710

120CFM Inlet 1/2" Outlets 2-3/8" Air Filter

SHA6920

Model 707F 3/4" In-Line Filter with Overnight Drain

SHA6910

Model 750FC 1/2" In-Line Filter and Coalescer

- Prevents fish-eyes by removing water, oil and contamination without the use of desiccant
- Designed for use in prep stations and air/finishing areas
- Stage 1 provides removal of water and contaminants down to 5 microns
- Stage 2 provides removal of oil and sub-micronic particles down to .01 microns
- Air flow capacity: 115 cfm



SHA6950

Model 880A Air Control Unit

- Highly effective at removing water, oil and contamination to protect air cylinders and air tools
- Contains 18C-3R regulator with a 160 lb. inverted gauge and air cock
- Regulated outlet and filtered main line outlet included
- Filter capacity: 75 cfm
- Regulator capacity: 50 cfm



SHA8130

Model F88 Air Filter

- Highly effective at removing water, oil and contamination
- Protects air cylinders and air tools and features a reusable edge-type filter element
- 5 micron filtration
- Filter capacity: 75 cfm



SHA6765-1

5 lb. Replacement Desiccant Beads

- 100% Silica Gel desiccant
- Use with the Dryaire Desiccant System



SGT99000

In Line Water Separator and Air Filter

- Removes water and foreign particles from compressed air stream
- Clear reservoir shows accumulated water taken out of air line
- Button release valve allows for easy disposal of accumulated liquid
- 1/4" NPT Male inlet x 1/4" NPT Female outlet



TIT19911

5 Piece In-Line Filter Screens

- Genuine VAPER® Replacement Part
- Fits all VAPER® Gravity feed spray guns
- In-line mesh filter removes dirt particles from paint to protect against defects



TIT19302

Disposable Air Line Filters, 2 Piece, for Paint Spray Guns

- Removes Moisture, Oil Vapor and Rust



BREATHING PROTECTION



Spray Equipment



SAT1005603

Air Vision 5000 Set with Air Regulator

- High breathing air quality: The air supply independent of the ambient air eliminates all potential risks for the painter by contaminated spray booth air.
- No inhalation resistance, very comfortable breathing
- High level of protection, suitable for prolonged application intervals
- Visor allows one-hand operation
- Non-reflecting view due to solvent-resistant special foil
- 1 year warranty on material and workmanship

Completely re-designed breathing air supply system. With its modern, ergonomic design, the hood can be adapted to fit almost any head shape, allowing the individual adjustment of its effective circumference, height and position



Spray Equipment



SAT214718

Air Vision 5000 with Carbon Regulator

- High breathing air quality: The air supply independent of the ambient air eliminates all potential risks for the painter by contaminated spray booth air
- No inhalation resistance, very comfortable breathing
- High level of protection, suitable for prolonged application intervals
- Visor allows one-hand operation
- Non-reflecting view due to solvent-resistant special foil
- 1 year warranty on material and workmanship

SAT1000223	Belt (for Air Vision 5000)
SAT1000314	Air Humidifier (for Air Vision 5000)
SAT1005596	Hood (for Air Vision 5000)
SAT1006990	Air Cooler with Plate and Pad (for Air Vision 5000)
SAT1007021	Air Warmer w/ Plate and Pad (for Air Vision 5000)
SAT1014232	Hip Pad (for Air Vision 5000 Air Warmer or Cooler)
SAT1014240	Air Tubing Assy (for Air Vision 5000)
SAT208280	Headband Assy (for SATA Air Vision 5000)
SAT208439	Belt w/ Buckle (for SATA Air Vision 5000)
SAT208462	Adapter Plate (for SATA Air Reg Belt)
SAT210405	5 Pack Visor Foils (for SATA Air Vision 5000)
SAT210468	20 Pack Visor Foils (for SATA Air Vision 5000)
SAT210526	100 Pack Visor Foils (for SATA Air Vision 5000)
SAT211904	4 Pack CCS Disc (for SATA Air Vision 5000)
SAT211912	20 Pack Hygenic Insert (for SATA Air Vision 5000)
SAT213728	10 Pack Sweat Band (for SATA Air Vision 5000)
SAT213736	6 Pack Visor Pin Set (for SATA Air Vision 5000)
SAT213751	Hood Holder (for SATA Air Reg)
SAT213835	Hook and Loop Tape Set (for SATA Air Vision 5000)
SAT215550	50 Pack Visor Foils (for SATA Air Vision 5000)
SAT215590	100 Pack Visor Foils (for SATA Air Vision 5000)
SAT218206	Activated charcoal element for sata air vision 50
SAT226456	Diffuser, plug-in (for sata air vision 5000)
SAT226621	Humidifier Module/Seal Kit
SAT226746	Hood Cloth, Dark Gray (for Air Vision 5000)

Air Regulators

- High breathing air quality: The air supply independent of the ambient air eliminates all potential risks for the painter by contaminated spray booth air
- No inhalation resistance, very comfortable breathing
- High level of protection, suitable for prolonged application intervals
- Visor allows one-hand operation
- Non-reflecting view due to solvent-resistant special foil
- 1 year warranty on material and workmanship

SAT1000075
Air Regulator with Belt (for Air Vision 5000)



SAT1000116
Air Regulator, Carbon, w/Belt (for Air Vision 5000)



SAT1000158
Air Warmer, Carbon (for Air Carbon Regulator)



SAT1000182
Air Carbon Regulator (for Air Vision 5000)



SAT1000207
Air Regulator (for Air Vision 5000)



SAT208447
Hip Pad (for SATA Air Regulator Belt)



PAINT SUITS AND BODY PROTECTION



Gen-Nex™ Painter's Coverall

- Liquid proof barrier protects against Isocyanate-based coatings
- Anti-static
- Lint free
- Heat dissipating cloth-like fiber
- Full zipper front, elastic wrists and non elastic ankle cuffs



- SAS6852 - Medium
- SAS6853 - Large
- SAS6854 - XLarge
- SAS6855 - XXLarge

SAS6894 XLarge Gen-Nex All-Purpose Hooded Painter's Coverall

- Full zipper front • Elastic wrists
- Non-elastic ankle cuffs

SAS6810 Overspray Socks

- Painter's spray sock
- Comfortable cotton blend
- Fits snugly around head and neck
- One-size-fits-all



Pair of Shoe Covers

- Shoes NOT included



- SAS6808 - Medium
- SAS6809 - Large

SAS5110 Overspray Goggles

- Impact resistant Polycarbonate lens
- Anti-splash: special vents prevent liquid from getting into eyes
- Sportstyle design with wide elastic headstrap
- Flexible PVC construction
- Anti-fog coating on lens



SAS6940 Moonsuit Coverall, Nylon - XXXL

- Moonsuit Nylon/Cotton Coverall
- Lightweight, Durable Rip-Stop Nylon Front
- Breathable, Cool Cotton Back
- Full Pullover Hood
- Velcro Wrist and Ankle Closures
- Zipper Front and Elastic Waist
- Washable/Reusable



ADDITIONAL SIZES AVAILABLE



KIM72214 XLarge Hooded Paint Suits

- Disposable
- Elastic wrist and ankles
- Hip pocket



WARNING: Cancer and Reproductive Harm - www.P65Warnings.ca.gov



MEGAPRON Mirror Glaze Shop Apron - Black

- 2 Pocket
- 34" Length
- Embroidered Color Logo



PAINT PREPARATION CUPS

3M



MMM16000 3M™ PPS™ Paint Preparation System Kit

- Kit contains 50 each standard size lids, filters, liners and sealing caps
- Graduated measurement to 20.3 oz. (with mix ratio film insert)



MMM16024 3M™ PPS™ Paint Preparation Kit - Large

MMM16114 3M™ PPS™ Paint Preparation System Kit, Mini Size, 200 Micron Filters

- Kit contains 50 disposable mini lids with 200 micron filters, 50 disposable liners, and 20 sealing plugs
- The 200 micron filters are recommended for traditional solvent based paint or primer applications
- Graduated measurement to 5 1/2 oz - with generic mix ratio film insert
- For use with part number 16115



MTN4202 Mountain Disposable Quart Mixing Cup (100 per case)

⚠ WARNING: Cancer and Reproductive Harm - www.P65Warnings.ca.gov



E-Z MIX®



EZX70032 Disposable 1 Quart Mixing Cups - 100/case

- Easy to use
- Works with all paint gun styles
- Quick clean up
- Environmentally safe



EZX70032L Disposable 1 Quart Lids - 100

EZX70016 Disposable Pint Mixing Cup 100/case

- Environmentally smart
- Recommended by the major paint companies



EZX70008 Disposable 1/2 Pint Mixing Cup, 100 Per Box

EZX70008L Disposable 1/2 Pint Lids, 100 Per Box



EZX70004 Disposable Paper Mixing Cups - 1/4 Pint Cups, 400 Per Box

- Supported by all major spray gun brands
- Environmentally safe
- Ideal for paint and body use

SATA

Spray Equipment



SAT125070 Rapid Preparation System

- A disposable cup system offering painting, refilling and storage of paint materials
- Completely disposable system - no cleaning
- Adapters to fit most guns - easy to use
- Can be used for a storage container - no waste
- Comes complete, no liners to keep up with - simple, effective, economical
- Includes 57 cups, lids and strainers
- Spray gun NOT included

TAPE

3M



Scotch® Performance 233+ Automotive Refinish Masking Tape

- High performance masking tape designed to exceed the needs of today's collision repair shops
- Highly conformable and has a specially formulated adhesive transfer resistance on rubber moldings and painted surfaces
- Performs consistently under a variety of climactic conditions
- Provides outstanding paint lines and a controlled, consistent unwind

Part #	Size	Rolls/Case
MMM26334	18mm x 55m bulk (3/4")	48
MMM26336	24mm x 55m bulk (1")	24
MMM26338	36mm x 55m bulk (1-12")	16
MMM26340	48mm x 55m bulk (2")	12

3M™ Automotive Attachment Tape, Gray

- .030" thick gray acrylic foam tape with proven performance acrylic adhesive and a red release liner
- Characterized by good peel and shear adhesion, good internal strength, conformability and good plasticizer resistance
- Typical applications would include the attachment of lightweight vehicle nameplates and trim, including narrow and light body side moldings



This is not recommended for medium to heavy weight trim attachment.

MMM6377 - 1/2" x 20 yds.

MMM6378 - 7/8" x 20 yds.

3M™ Automotive Refinish Masking Tape

- Designed to meet today's paint technicians requirements for masking before painting
- No adhesive transfer
- No edge lifting
- Waterborne paint system compatible



Part #	Size	Rolls/Case
MMM6652	18mm x 55m	48
MMM6654	36mm x 55m	24
MMM6656	48mm x 55m	24

3M



3M™ Automotive Acrylic Plus Attachment Tape, Black,

- .045" thick, medium density black acrylic foam tape with high performance acrylic adhesives on both sides and a red release liner
- Uses automotive OEM approved acrylic foam core and adhesive technology
- Stronger, higher performing, stress handling products than other automotive attachment tapes

Part #	Size	Color
MMM6382	1/2" x 20 yards	Black
MMM6383	7/8" x 20 yards	Black
MMM6384	1/2" x 5 yards	Black
MMM6386	1/4" x 20 yards	Black



Scotch® Plastic Tape 471, Blue

- Uniquely constructed, vinyl backed tape for outstanding paint line definition
- The most flexible and conformable, it provides masking protection for complex curved lines, sharp curves, irregularly shaped panels, over rivets and into seams

Part #	Size	Color
MMM6404	1/8" x 36 yards	Blue
MMM6405	1/4" x 36 yards	Blue
MMM6408	1/2" x 36 yards	Blue
MMM6409	3/4" x 36 yards	Blue



MMM6975

3M™ Duct Tape 3939, Silver, 48mm x 54.8m

- Economy grade duct tape
- Polyethylene coated cloth backing with rubber adhesive
- High tack, conformability, strength and easy tear make 3939 ideal for many duct and moisture sealing, holding, protecting and bundling applications

TAPE

3M



MMM6297

3M™ Soft Edge Foam Masking Tape (D.A.R.T.) 12mm

- A foam tape designed to be used in masking door jambs, hood or deck lid openings or other areas of a vehicle which need to be sealed during the painting operation
- Unique adhesive allows material to be repositioned
- Eliminates rework due to unwanted tape lines
- Provides a "soft edge" to prevent tape lines in the jamb areas
- 12mm (1/2") diameter x 54.6 yards (50 meters)

Applications include: hood and trunk, doors, door jambs, gas caps, other openings and in the engine compartment.

MMM6298

3M™ Soft Edge Foam Masking Tape (D.A.R.T.) 19mm

- 19mm (3/4") diameter 27.3 yards (25 meters)

3M™ Trim Masking Tape, 50.8mm x 10m

- 7mm wide hard band designed to actually lift up the molding from the vehicle, allowing paint to flow under the molding
- This tape works particularly well on flush mount windshield and back glass moldings



The firm strip of this tape is slid under the molding. The liner on the remaining adhesive side is then removed and the tape is folded over and adhered to the glass, actually lifting up the molding and allowing paint to flow under it. This tape saves time, labor, and the cost of removing and installing new moldings, plus the removal of paint lines on existing moldings.

MMM6347 - 7mm Hard Band

MMM6348 - 15mm Hard Band

MMM6349 - 10mm Hard Band



MMM6951

Post-It® Labeling Tape 695, 2" x 36 yds, White

- Secure yet removable tape for temporary labeling and copy blockout
- This tape has a white paper backing with a low-tack acrylic adhesive
- Use anywhere - label bins, shelves and drawers, sticks firmly, removes easily



COLOR MATCH LIGHTS

SATA

Spray Equipment



SAT1012129

True Sun LED Light

- Near perfect daylight conditions on any color shade; no need to move the project outside
- Uniform distribution of the light intensity across the entire light cone
- Battery life approximately 70 minutes at full light intensity, lasting for an entire days production in most shops
- Uniform light intensity – unaffected by the battery charge level
- Fast charging cycle time of approximately 50 minutes

SAT1013094

Carrying Case with Foam, True Sun LED Light

SAT1012137

Lens Only, True Sun

3M



MMM16550

3M PPS Sun Gun II Light Kit

- Longer battery run time
- Wider, more even light beam
- Choose the correct variant or alternative color chip, verify coverage and color match
- Identify post-paint defects such as swirl marks, burn through, sand scratches and dirt-nibs
- Improved battery charger
- 90 day warranty on material and workmanship

Astro

AST50SL

SunLight 400 Lumen Rechargeable Color Match Light

- Highest color match rating (CRI 97) of any LED light on the market
- Spots color differences and paint imperfections like only a high CRI color match light can
- Easily removable and cleanable lens
- Collapsible 360° rotating hook
- 180° folding magnetic base and Impact resistant



PAINT DRYING



SAT217489 Lightweight Blow Gun Makes Quick Work of Drying Waterborne Material

- Lightweight blow gun makes quick work of drying waterborne material
- A special nozzle design multiplies air volume from ambient air using the venturi injection principle
- An air intake filter prevents contamination of paint material
- Air consumption is only 9.5 CFM at 35 psi
- The CFM is magnified to 10x to give 92.35 CFM output
- 1 year warranty on material and workmanship



PAINT DRYING, CURING AND SHAKING



DENDF-EZAP StaticZAP Anti-Static Device

- Keeps the surface clean during the paint process to avoid unnecessary reworking and buffing
- Incorporates the efficiency and power of an air amplifier with the proven technology of corona ionization to produce a highly effective anti-static blow-off gun.
- Perform the anti-static blow off before starting and at every stage in the painting process to eliminate fisheyes and produce a finish that looks like glass.
- The two-minute anti-static process will reduce the time needed for wet sanding and buffing which saves time on prep work and also cuts down on labor and materials.
- 1 year warranty on material and workmanship



AST4550A Air Operated Paint Shaker

- New and improved clamp size to accommodate container size ranging from pint to gallon and even larger European paint containers
- Lightweight, heavy duty construction and a compact design
- Adjustable locking rubber coated clamps offer increased grip while shaking and to accommodate pints, quarts, gallons and larger European containers
- Includes oiler and 1 year warranty

WARNING: Cancer and Reproductive Harm - www.P65Warnings.ca.gov



PTKAF-08 JETAIR Air Dry Fan with Stand

- Low air consumption
- High air output
- Long reach, less moving the fan in the booth
- Oil-less air motor, no leaking oil in the booth
- Stainless steel construction
- 1 year warranty on material and workmanship



PAINT DRYING, CURING AND SHAKING



BLR51000

Tornado II Electric Paint Shaker

- Mixes paints completely utilizing three axis of motion, including orbital, side-to-side, and up/down
- The fewer moving parts minimizes noise while the paint shaker is in operation
- A quick and easy to use four point clamping mechanism securely holds containers during the agitation cycle
- Blending cycles can be set to numerous time intervals via the convenient up-front control panel
- 115 Volt motor • Portable



SHA6770

Dryaire Membrane Air Drying System

- Advanced air drying technology for shop use
- Lightweight, easy to install, and simple-to-operate
- Maintains -40° F dew point while achieving 0% compressed air humidity
- Removes oil and sub-micron particles down to .01 micron
- Stage 1 filter provides removal of water and contaminants down to 5 micron. Stage 2 coalescer provides removal of oil and sub-microns particles down to .01 microns; Stage 3 membrane dryer is maintenance free, no regeneration required.



INFSRU1615

1500W Infrared Heat Lamp Portable Curing System, 120 Volt

- UL Listed
- The most economical infrared heaters on the market
- Heavy-duty construction can stand up to the punishing conditions in any body shop
- 1,500 watts of power
- Covers up to 24 square feet

Available in 120 or 240 volts, this portable unit comes with a heavy-duty stand and casters. Its stand adjusts to 6' tall. The SRU-1615 is dependable, versatile and unbelievably affordable. Maybe that's why over one million "Speed-Rays" have been sold. The SRU-3215 is the same great unit as the SRU-1615 except it has two heads instead of one. This doubles the amount of coverage to 24 square feet. These units are suitable for use with all automotive-type finishes. Ideal for small spot repair and curing body filler.

INF10-1065

Bulb for INFSRU1615

MASKERS

AP Astro



**AST4577
Mobile Step Masking Machine**

- Lightweight and portable
- Dispenses rolls up to 18" wide
- Sharp, anodized blade for smooth cutting
- Can be used as a stepstool
- Holds one roll of paper and

⚠ WARNING: Cancer and Reproductive Harm - www.P65Warnings.ca.gov

**ASTASMS2
Masking Station - Tree Type**

- Includes bars for 4 paper rolls up to 18" and 4 tape rolls
- Nonskid rubber wheels make it possible to move masking station to job
- Wide-base design prevents toppling as paper is dispensed
- Double welded durable lightweight steel frame
- Easy loading for paper rolls and tape
- Weight: 27 lbs.

⚠ WARNING: Cancer and Reproductive Harm - www.P65Warnings.ca.gov



AP Astro



**ASTMM18
18" Masking Machine**

- Includes bars for two (2) paper rolls and four (4) tape rolls
- Large adjustable washers maintain paper alignment
- Wing nuts for easier paper loading
- Sharp, anodized blade for smooth cutting
- Large storage tray on bottom for tools

⚠ WARNING: Cancer and Reproductive Harm - www.P65Warnings.ca.gov

**AST9004
4 Piece Heavy Canvas
Wheel Masker Set
for 13-15" Tires**

- Ideal for protecting wheels and tires from paint during paint job

⚠ WARNING: Cancer and Reproductive Harm - www.P65Warnings.ca.gov



PAINT & BODY | tools



**ALC78014
36" Deluxe Plastic / Paper Masker**

- Holds 36" plastic, and 36" paper plus 2 additional rolls of paper
- A complete mobile masking cart
- Tool-less paper loading, no tools necessary to load paper
- Dual tape dispensers



**ALC78004
18" Double Roll Mobile Masker**

- Tool-less paper loading
- Large knobs can be removed and re-installed by hand
- Has a one piece cutting bar and dual tape rolls
- Made with 2 wheels for easy maneuvering

⚠ WARNING: Cancer and Reproductive Harm - www.P65Warnings.ca.gov

MASKERS



ALC33004
Vantage
Paper Tree Masker

- Bar 1; 3" roll
- Bar 2; 3" to 6" roll
- Bar 3; 3" to 12"
- Bar 4; 3" to 18"
- Hold 4 bars of paper ranging from 3" to 18"

⚠ WARNING: Cancer and Reproductive Harm - www.P65Warnings.ca.gov



ALC78007
12" and 18"
Multi-Roll Masker

- One piece cutting bar and dual tape rolls on all dispensers
- Tool-less paper loading
- Narrow 22" profile rolls between cars in shop
- Large knobs can be removed and re-installed by hand
- Masker holds 2 rolls of 18" paper and 2 rolls of 12" paper or smaller

⚠ WARNING: Cancer and Reproductive Harm - www.P65Warnings.ca.gov



ALC78009
36" Wall Mount Masker

- Notched tubular design for added strength
- Sturdy one piece cutting bar
- Dual metal tape dispensers
- Tool less paper loading - No tools needed to load paper
- Does not take up floor space

⚠ WARNING: Cancer and Reproductive Harm - www.P65Warnings.ca.gov



ALC78012
36" 2 Roll Vertical Masker

- Narrow profile 22" to roll between cars in shop
- Holds a roll of 36" paper and a roll of 36" cut plastic with knife
- One piece cutting bar and dual tape rolls
- Large knobs can be removed and re-installed by hand

⚠ WARNING: Cancer and Reproductive Harm - www.P65Warnings.ca.gov



ALC78011
18" Wall Mount Masker

- Mount on wall- out of way
- Notched tubular design for added strength
- Sturdy one piece cutting bar
- Dual metal tape dispensers

⚠ WARNING: Cancer and Reproductive Harm - www.P65Warnings.ca.gov



ALC78002
18" Portable Masker

- Large knobs can be removed and re-installed by hand
- Tool-less paper loading
- 18" in length
- One piece cutting bar and dual tape rolls

⚠ WARNING: Cancer and Reproductive Harm - www.P65Warnings.ca.gov



ALC78003
36" Portable Masker

MASKING PAPER / PROTECTIVE COVERS



ALC78015

Masker Prep Station

- Holds the most popular sizes of masking paper
- Features a separate bar for plastic rolls
- Paint gun holder and convenient upper tray for miscellaneous tools and supplies
- Four swivel casters with two locking to prevent roll



Large top tray 22" x 46", holds tools and tape; holds 36" plastic on top bar; holds up to 2 rolls of 18" paper - bar #2; holds up to 2 rolls of 18" paper - bar #3; holds up to 1 roll of 36" paper - bottom paint gun holder.



MMM37853

3M™ Dirt Trap Protection Material Gray, 56" x 300'

- Specially engineered covering material
- Protects paint booth walls and floors and brightens work areas
- Its non-woven construction traps dust and overspray and its bright white color creates better visibility for technicians and a more pleasant shop appearance for collision repair customers
- Adhesive backing keeps it secure, smooth and wrinkle free
- Brightens work areas
- Its non-woven construction traps dust and overspray



MMM37852

3M™ Dirt Trap Protection Material Gray, 28" x 300'



3M™ White Masking Paper

- Masking paper with excellent resistance to paint solvents, urethanes, base coats and clear coats
- Conformable
- Tightly bonded paper for little no lint and fiber contamination



MMM6537 - 6" x 750'

MMM6538 - 12" x 750'

MMM6539 - 18" x 750'

MMM6540 - 36" x 750'



MMM6728

3M™ Overspray Protective Sheeting, 16' x 350'

- High density, tear resistant, clear durable film that is treated for excellent paint over spray adhesion
- Sixteen foot accommodates larger sedans, mini-vans, small pick up trucks, and Suva
- Thicker film now .4 mil; better cling to the vehicle
- Better corona treatment for enhanced paint over spray anchorage
- Use with Masker part number MM6780

MMM6742

3M™ Overspray Protective Sheeting, 20' x 250'

- Twenty foot roll accommodates larger vans, full size pick up trucks, and large SUV's



MMM6727

3M™ Overspray Protective Sheeting, 12' x 400'

- High-density, tear resistant, clear durable film that is treated for excellent paint overspray adhesion
- Twelve foot film accommodates smaller cars
- Thicker film now .4 mil
- Better cling to the vehicle
- No longer has center seam



MASKING PAPER / PROTECTIVE COVERS

3M



MMM36900 3M™ Interior Protection Automotive Seat Cover

- Designed with a top pocket to allow easy positioning of the cover on all seat configurations
- Constructed with a unique 2-layer technology that keeps the cover in place while allowing easy movement in and out of the vehicle
- Resist tearing

MMM36901 3M™ Interior Protection Automotive Floor Mat

- Floor mats are treated to resist moisture
- Packaged 250 per box
- Generous sized 17" x 22" floor mat
- Less time and expense spent on detailing and clean up after repair is completed



RBL PRODUCTS, INC.

AUTOMASK®



RBL438 Self-Adhering Spray Booth Protective Film - Clear 36" x 100'

- Clear, non-yellowing, see-through film applies directly over white booth walls and doors.
- Easy to handle, lightweight reverse-wound 36" wide roll.
- Strength of adhesive supports weight of roll preventing roll from running down the wall
- Reverse-wound roll enables wrinkle-free, bubble-free application against booth walls
- Eliminates repeated coats of white booth coating
- Cuts booth maintenance time in half!
- No mess. No cleaning of spray gun
- Film resists heat up to 200°F (93.3°C)
- Preserves booth lighting without distortion or deflection
- Quick installation time

NORTON



Polycoated Masking Paper

- Polycoated to protect against paint bleed through
- Corona treatment allows the paint to adhere to the paper rather than flake off
- Thick, high strength masking paper

NOR05479 - 12" x 750'

NOR05480 - 18" x 750' - 2 Rolls

NOR05482 - 18" x 750' - 2 Rolls



White Polycoated Masking Paper

- Water and solvent resistant
- Built in paint check - check your coverage right on the paper
- Strong, durable, yet flexible and user-friendly
- Resists tearing. Tape can be re-positioned on the paper without ripping
- White - no reflections or glare in the paint booth

NOR00403 - 12" x 750'

NOR00404 - 18" x 750'

NOR00407 - 36" x 750'



NOR06728

16FT x 400FT Plastic Sheeting

- Paintable
- Medium-density, corona-treated plastic.
- Value sheeting that performs like premium



NOR03345

Blue Poly Sheeting 16' x 350'

- Easy to handle-fast application
- Clings after repositioning
- Holds paint like paper
- Resists tearing
- Resistant to solvents
- No bleed-through
- One pass coverage
- Fast application increases productivity
- Paint won't flake off-eliminates use of paper

NOR03723

20' x 350" Roll of Blue Sheeting

MASKING PAPER / PROTECTIVE COVERS

VANTAGE TOOL



ALC33003
18" Portable Masker

- Lightweight: 9 lbs.
- Bar holds 1 roll 3" to 18"
- The feet have rubber caps- non-skid or mar
- Handle is made for a no-slip grip

WARNING: Cancer and Reproductive Harm - www.P65Warnings.ca.gov



KILART246
Hose Glider

- Keep air hose off the paint booth floor
- Hose glides easily on roller wheels
- No more tangled or kinked hoses
- 21' of track for each side of booth
- 1 year warranty on material and workmanship



WORK TREES AND STANDS

PAINT & BODY | tools



ALC77782
Keysco Bumper Stand

- Designed to hold the entire bumper securely
- Tubes extend to firmly hold "floppy ends" of plastic bumpers
- Adjusts up and down, in and out
- Quality built at an affordable price



ALC77785
Deluxe Bumper Stand

- Allows you to work on the outside and inside of any bumper
- Tubes extend to firmly hold "floppy ends" of plastic bumpers



This Deluxe bumper stand comes complete. It includes support tubes, padded hoop and padded u-shaped brackets. This swivels 180-degrees while holding the bumper securely. Also it adjust up, down, in and out.

WARNING: Cancer and Reproductive Harm - www.P65Warnings.ca.gov

WORK TREES AND STANDS



ALC77786 Economy Fender Stand

- Holds two fenders securely for prep and painting work
- Adjustable arms support the skirts of fenders
- Stand is height adjustable
- Stand folds for storage: 31"W x 38"L x 45"H

WARNING: Cancer and Reproductive Harm - www.P65Warnings.ca.gov



ALC77784 Bumper Rack

- Protects and organizes bumpers
- Holds 6 or more 18" arms
- Arms fold down to take up very little room when not in use
- 15" between arms

WARNING: Cancer and Reproductive Harm - www.P65Warnings.ca.gov



URE6075 Bumper Mate 2

- Securely holds flimsy bumper fascia so only one technician needs to work on it
- Holds odd-shaped headlight when used with bungee cords
- Extends the function of your shop's folding work stands to support a variety of parts
- Has strategically placed openings for clamping and bungeeing parts



STC21870 E-Z Rest Door Hanger

- Padded, removable side rails
- Easy on/off design and fully adjustable
- Hang bumpers, store glass, many other uses
- Quickly adapts to most floor jacks with removable saddles
- Fits jacks with saddle hole dimensions of 1.17" - 1.19"
- 90 day warranty on material and workmanship



ALC78030 5 Gallon Pail Tipper

- Holds one standard 5 gallon pail
- All-steel tube construction with formed handle for easy pouring
- Top support for easy moving

WARNING: Cancer and Reproductive Harm - www.P65Warnings.ca.gov



ALC77783 Keysco Pick Up Bed Dolly

- Adjustable heights 21", 24", 27"
- 4 casters, two of them are locking

WARNING: Cancer and Reproductive Harm - www.P65Warnings.ca.gov

VANTAGE TOOL

ALC73783 Aluminum Pickup Bed Dolly

- Lightweight, but very strong
- 4" locking swivel casters
- Folds flat in seconds
- Extra tubing that bolts to legs for extra support

WARNING: Cancer and Reproductive Harm - www.P65Warnings.ca.gov



KILART45 Heavy Duty Door Lift Operated by Air Ratchet

- Removing or replacing doors is now a 1 man job. Our heavy duty door lift is operated with a 3/8 inch air ratchet for precision lifting.
- Built to last with 1-1/2" steel tubing
- Precision height adjustment
- Self leveling arms that tilt and lock
- Wide stance for stability



WORK TREES AND STANDS



STC35800

Bumper Tree

- Tilt while painting to give easy access to top, bottom, front, back and wrap-around ends
- Openings in covers can be painted from the front and back to assure complete coverage
- Bumper cover is secured by chains - chains are adjusted using convenient chain slots
- Tilt feature allows you to set your own working height and angle



STC35900

Panel Tree

- Center post design allows access to edge, bottom, and both sides of panel
- Paint panels, jams, and car all at one time
- Save hours of dry time compared to separate painting
- Holds doors, fenders, hood trunk lids and more



Tire Steps



ESC60203

Tire Step - 400 lb. Capacity

- Heavy duty portable safety step
- Use on standard size truck tire
- Easy way to service truck engine compartments
- Folds for compact storage (less than 4")



Hangs onto the top of the truck tire allowing the technician to work under the hood without bulky stepladders or stools.



OTC1534A

Tire Step - 300 lb. Capacity

- Fits passenger and light trucks
- Provides quick, easy access to your vehicles roof for loading/unloading cargo
- Installs in seconds; adjusts to fit 14" to 20" wheel sizes
- Dimensions: 22.8" wide x 16.1" deep
- Non-skid platform surface • Two-year warranty



WARNING: Cancer and Reproductive Harm - www.P65Warnings.ca.gov

Stands



KTI79750

Adjustable & Foldable

Work Stand - 41 x 43 x 35"

- Length: 40.551" (103cm); Adjustable
- Width: 23.819" (60.5cm) - 43.307" (110cm);
- Adjustable Height: 29.134" (74cm) - 35.039" (89cm)
- Load Capacity: 500 lbs
- Sturdy powder coated tubular steel frame with machine-welded seam
- Heavy gauge chain has 6 connectors, which can be placed to adjust height and width
- Red legs with non-skid tips
- Covered by a 1-year warranty



KTI79755

Adjustable & Foldable

Work Stand - 31 x 36 x 41"

- Length: 31.102 (79cm); Adjustable
- Width: 20.866" (53cm) - 36.024" (91.5cm); Adjustable Height: 31.890" (81cm) - 41.339" (105cm)
- Load Capacity: 750 lbs
- Covered by a 1-year warranty

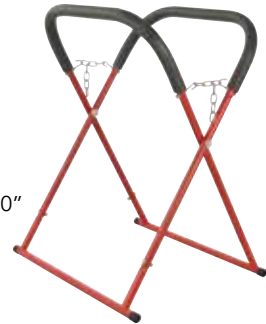

AST7300

Universal Rotating Super

Work Stand for Paint and Body

- Comes with 8 adjustable bars to fit almost any panel securely
- Allows for fast and easy moving of the part from the prep station to the spray booth
- Allows for single handed rotation of panels 350 degrees in 16 degree increments
- Includes bottom parts tray for storage of bars and other tools
- Weight Capacity: 200 lbs.
- 1 year warranty on material and workmanship



WARNING: Cancer and Reproductive Harm - www.P65Warnings.ca.gov

WORK TREES AND STANDS

Stands

Astro

AST557012 Panel Stand

- Lightweight with 300 lbs. capacity
- Bumper extension bar can easily be adjusted for any position
- Great for working on bumpers and other automotive parts
- Adjustable height: 34-1/2" to 47" high

Steel tubing construction with 1-1/4" (32mm) O.D. round tubing and 1-3/16" (30mm) O.D. square tubing. Weight: 18.7 lbs.

WARNING: Cancer and Reproductive Harm - www.P65Warnings.ca.gov



AST557003 500 lb. Capacity Portable Work Stand

- Lightweight work bench
- Steel tubing construction with a 1/2" foam padded top
- Great for working on doors, fenders, hoods and bumpers
- Adjustable height of 33" to 40" tall
- Tube diameter is 1"
- Chains included

WARNING: Cancer and Reproductive Harm - www.P65Warnings.ca.gov



AST557005 500 lb. Capacity Portable Work Stand with Sling

- Lightweight work bench
- Steel tubing with 1/2" foam padded top
- Great for doors, fenders, hoods and bumpers
- Adjustable height of 33" to 40" tall
- Sling easily attaches with hook and loop fasteners

WARNING: Cancer and Reproductive Harm - www.P65Warnings.ca.gov



AST557010 Extra Heavy Duty Portable Work Stand

- Heavy Duty work bench with capacity of 500lbs.
- Steel tubing construction with 1/2" foam padded top
- Adjustable height of 25" to 41" tall
- Weight: 16 lbs.
- Chains included

WARNING: Cancer and Reproductive Harm - www.P65Warnings.ca.gov



Astro

AST557100

The Fender Extender - 80" Adjustable Extension

- Extension tailored for long or wide bumpers, hoods and fenders that would normally be difficult to balance on a work stand
- 3 way adjustable from 77.5" to 80" in length, works on any tube design work stand
- Bungee cord loop attached for tying down work piece
- Works best on stand height settings of 30-36" (or affixed w/ 5-6 chain lengths)
- Center hook separation distance 24.5-26.5"

WARNING: Cancer and Reproductive Harm - www.P65Warnings.ca.gov



ALC77781 Keysco Van Stand

- 48"L x 16"W x 18"H
- Safety yellow with non-skid surfaces
- Sturdy work stand to reach tops of vans and trucks
- Use to reach and service engines on large trucks

WARNING: Cancer and Reproductive Harm - www.P65Warnings.ca.gov



SANDING BLOCKS



Conformable Sanders

- Can hold a desired hand-pressed geometry
- Slide interface that works with standard 2-3/4 sand paper
- A generous gripping area on block reduces fatigue
- The thin, flexible slide allows shape to be changed without buckling or tearing sand paper
- Hook & Loop

MALCSH5 - 5 inch MALCSH8 - 8 inch



Replacement Slides

- Convenient 3 Pack
- The thin, flexible slide allows shape to be changed without buckling or tearing sand paper
- Hook & Loop

MALCSH5S - For MALCSH5



SANDING BLOCKS



HiTech Finesse Sanding Blocks

- Excellent for completely removing runs, sags, and other small, isolated defects on top of any paint surface
- Safe and effective for use on all paint finishes, including high-tech clearcoats
- Precisely uniform grit particles leave a smooth, even sanding pattern that's easy to clean and polish to a flawless finish



- MEGK1000 - 1000 Grade**
- MEGK1500 - 1500 Grade**
- MEGK2000 - 2000 Grade**

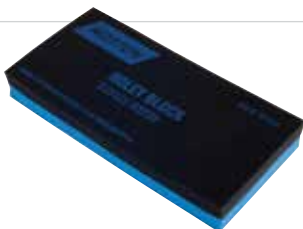

NOR03729

Holey Sanding Block

- A rugged, semi-rigid, multi-purpose sanding block engineered for flat to medium curved surfaces
- A tactical hole pattern side provides numerous cutting edges to create a 30% faster cut rate
- The plain side provides firmness and a comfortable, easy-to-hold surface



NOR03728

Dual Density Wet Sanding Block

- Because of the "grabbing" power of these blocks, no adhesive is required, simply wrap the paper around the block
- The dense side is for more aggressive blocking, while the soft side is for color sanding

NOR01889

Rubber Hand Sanding Block

- Ideal for uniform sanding
- Can be used for dry or wet sanding
- Slotted jaws securely hold sheets in place



NOR42090

Soft PSA Hand Block 2-3/4IN x 5IN

- Constructed of flexible, yet tough, foam and shaped to fit comfortably in your hand
- The design is good for both flat surfaces as well as contours
- The embossed rubber face allows for good adhesion of PSA sheet rolls



WARNING: Cancer and Reproductive Harm - www.P65Warnings.ca.gov



MMM5440

3M™ Stikit™ Hand Block - 2-3/4" x 5"

- Made of sturdy, durable, high strength material
- Shaped to fit the hand comfortably
- Embossed rubber face which allows good adhesion for Stikit sheet rolls and Stikit Production Sheets
- This block uses 3m™, it's unique Stikit™ attachment system

MMM5441

3M™ Stikit™ Hand Block - 2-3/4" x 7-3/4"

MMM5442

3M™ Stikit™ Hand Block Soft - 2-3/4" x 5"

- Soft molded foam block with easy release hook face
- Use with Stikit™ sheet rolls 2-3/4" wide or abrasives sheets 2-3/4" x 5" for leveling of repair area or following contours
- Made of a tough flexible foam which allows the user to block sand on flat surfaces or contours
- Stikit™ sheets adhere firmly and won't slip or tear

MMM5519

3M™ Rubber Sanding Block, 2-3/4" x 5"

- A pliable rubber block which holds sandpaper securely during wet or dry sanding operation
- Uses a 2-3/4" x 9" sheet



MMM5520

3M™ Rubber Sanding Block, 3" x 8"

- Uses a 3" x 11" sheet



3M™ Stikit™ Hand Pads

- Designed to be used with all grades of 3M™ Stikit™ Discs
- These hand pads are firm yet comfortable and are lightweight, making sanding of such areas as next to chrome and trim, corners and contours easier



MMM5585 - 5"

MMM5586 - 6"



Sanding Blocks

- Easy to affix paper to steel spikes molded into block
- Holds paper securely
- Use with wet or dry sandpaper on flat or curved surface



SGT89800 - 5"

- Uses standard 3" x 8" sandpaper

SGT89810 - 9"

- Uses standard 9"x11" sandpaper cut into thirds

WARNING: Cancer and Reproductive Harm - www.P65Warnings.ca.gov

SANDING BLOCKS

Dura-Block
The Perfect Finishing Tools



TADAF44L
6 Piece Dura-Block Sanding Kit

- Uniform machined surfaces
- Hard surface tension
- Multiple blocks in one kit covers a variety of jobs
- Flexible
- Patented
- Includes most of the popular blocks in the Dura-Block line

Contents:

- TADAF4400 - Dura-Block Standard Sanding Block
- TADAF4401 - 1/3 Dura-Block 5-1/4" Sanding Block
- TADAF4402 - 2/3 Dura-Block 10-1/2" Sanding Block
- TADAF4403 - Dura-Block 16-1/2" Full Size Sanding Block
- TADAF4404 - Dura-Block 11" Tubular Sanding Block
- TADAF4405 - Dura-Block Scruff Block

Dura-Block Sanding Blocks

- Precision machined surface
- Hard surface tension
- Flexible
- Patented



Dura-Block
The Perfect Finishing Tools



TADAF44HL

7 Piece Dura-Block Hook and Loop Sanding Blocks

- Dura-Block conforms to the panel curve
- Will not dig into fill material
- Hook and loop allows use of money saving hook and loop paper
- Known worldwide as the gold standard in blocks
- Product is machined to a perfect, flat finish

Contains the most popular Dura-Blocks in money saving Hook and Loop attachment. This allows reuse of paper when changing grits. The patented materials used in Dura-Blocks allow them to conform to the panel curve yet the surface hardness prevents digging into fill materials. Simply the best blocks available.

Part #	Size	Description	Application
TADAF4400	3/4" x 1 3/8"	Standard Sanding Block	Curved or flat panels
TADAF4401	1-3/8" x 2-5/8" x 5-1/2"	1/3 Dura-Block 5-1/4" Sanding Block	Slightly curved or flat panels
TADAF4402	1-3/8" x 2-5/8" x 11"	2/3 Dura-Block 10-1/2" Sanding Block	Small to medium panels
TADAF4403	Fits standard 2-3/4" width sand paper either pre-cut or rolls	Dura-Block 16-1/2" Full Size Sanding Block	Large flat or slightly curved surfaces
TADAF4404	Fits standard 9" x 11" wet or dry sheet of sandpaper	Dura-Block 11" Tubular Sanding Block	Hard to sand areas
TADAF4405	1/2", 2 1/2", 5 3/8"	Dura-Block Scruff Block	Sanding and prep work
TADAF4406	Fits standard 9" x 11" wet or dry sheet of sandpaper	Dura-Block Tear Drop Sanding Block	Hard to sand areas
TADAF4409	Fits standard 9" x 11" wet or dry sheet of sandpaper	Dura-Block 24" x 2" Sanding Block	Medium to large panels
TADAF4410	Fits standard 9" x 11" wet or dry sheet of sandpaper	Dura-Block 30" x 2" Sanding Block	Large panels

SANDING BOARDS

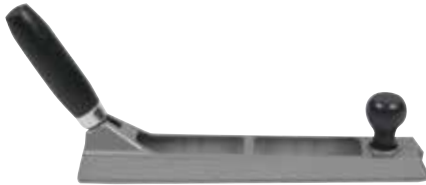

**ALC77290
Body File Holder**

- Die cast frame with gray enamel finish
- Three position handle

WARNING: Cancer and Reproductive Harm - www.P65Warnings.ca.gov



**ALC77347
8 Tooth Flat Body File**

- Use on lead, solder and all type body fillers
- Can be used to file flat, concave or convex surfaces
- Teeth on both sides extends life of tool
- Use with 77753 and 77348 file holders

WARNING: Cancer and Reproductive Harm - www.P65Warnings.ca.gov



**SGT89920
Sanding Board**

- Lever style clamps hold paper tightly in place
- Smooth hardwood handles are contoured for comfort and mounted on a sturdy rust-proof, aluminum base with cushioned bottom
- Ideal for wet or dry sanding on any surface
- Uses standard cut abrasive paper, 2-3/4" x 17-1/2"

WARNING: Cancer and Reproductive Harm - www.P65Warnings.ca.gov



**HUT5501
Sand-Board 2-3/4" X 17"**

- Lightweight, nearly indestructible Cyclocac Plastic for flexibility and long life
- Flat surfaces or curves
- Wet or dry sanding, standard 2-3/4" x 17-1/2" sandpaper



**HUT5502
Sand-Board 2-3/4" X 17"**

- Tough and versatile
- Featherweight tempered aluminum with cushioned base
- Wet or dry sanding
- Uses 2-3/4" x 17-1/2" sandpaper



**HUT5504
Sand-Board 3" X 11"**

- All purpose sanding
- Specification aluminum base with rubber cushion for grab
- Wet or dry sanding
- Use 3" x 11" sheet

PAINT & BODY | tools

BACKING PADS



Backing Pads

- For angle DA random orbital sanders
- Pad is made of polyurethane
- 5/16"-24 UNF thread

WARNING: Cancer and Reproductive Harm - www.P65Warnings.ca.gov

AST4605 - 5" PSA

- Maximum RPM: 12,000

AST4606 - 6" PU Velcro

- Maximum RPM: 10,000

AST4607 - 5" PU Velcro

- Maximum RPM: 12,000

AST4608 - 6" PSA

- Maximum RPM: 10,000

**AST20302P
Pad Backing 3" for Sander/Polisher
Mountain & Astro**

- 3" diameter
- 5/16" x 24 Thread

WARNING: Cancer and Reproductive Harm - www.P65Warnings.ca.gov



NEW

DYNABRADE NITRO SERIES™ ABRASIVE POWER TOOLS



DYBNF1 – .5 hp, 20,000 RPM Nitrofile

– Runs Belts 1/4" – 3/4" wide by 18" long

DYBMNF1 – .4 hp, 25,000 RPM Mini-Nitrofile

– Runs Belts 1/2" wide by 12" long

Quickly grind through spot welds for a fraction of the cost of using expensive spot weld cutters. Abrasive belt tools also blend welds, grind through seized bolts or even remove seam sealer making them a must have, versatile tool for any shop.



DYBDS32 – 2" Dia. Right Angle Disc Sander

DYBDS53 – 3" Dia. Right Angle Disc Sander

Ideal for quick weld removal, metal beveling in weld preparation, deburring and deflashing, surface conditioning and paint removal. Accept locking-type abrasive discs.



DYBDGS31 – .3hp Die Grinder

DYBDGS51 – .5 hp Die Grinder

Compact, lightweight tools with smooth and efficient air motors. 1/4" collet allows for the use of burs along with coated and non-woven abrasives in a variety of shapes and sizes.



DYBEB3 – 3" Dia. 2,700 RPM Extended Buffer

This extended buffer is perfect for use in tight areas of contoured painted surfaces, like side-view mirrors.



DYBECU4 – 4" Dia. Extension Right Angle Cut-Off Wheel Tool

Provides the operator with greater control of the tool while working above head, in a difficult to reach area.



DYBRB1 – 5" – 8" Dia. Buffer, 2,800 RPM

Quickly polish large areas like hoods and trunk lids with consistent results. Accepts 5" – 8" diameter buffs. (5/8"-11 Male Spindle)



DYB50208 – Random Orbital Buffing Kit

Includes:

- DYBROB1 Electric Random Orbital Buffer
- 5" Hook-It Pad, 5/8"-11 Thread
- 5-1/2" DYNACUT™ White Foam Flat Face Polishing Pad
- 5-1/2" DYNACUT™ Orange Foam Flat Face Polishing Pad
- 5-1/2" DYNACUT™ Top Wool Polishing Pad, H & L
- DYNARED® Polishing Compound, 1 Liter
- DYNAORANGE® Polishing Compound, 1 Liter
- 2 – 12" x 12" Premium Microfiber Wipes
- Kit Carry Bag



DYB50209 – Rotary Buffing Kit

Includes:

- DYBRB3 Variable Speed Rotary Buffer/Polisher
- 5" Hook-It Pad, 5/8"-11 Thread
- 5 1/2" DYNACUT™ White Foam Flat Face Polishing Pad
- 5 1/2" DYNACUT™ Orange Foam Flat Face Polishing Pad
- 5 1/2" DYNACUT™ Top Wool Polishing Pad, H & L
- DYNARED® Polishing Compound, 1 Liter
- DYNAORANGE® Polishing Compound, 1 Liter
- 2 – 12" x 12" Premium Microfiber Wipes
- Kit Carry Bag

SEE MORE GREAT DYNABRADE PRODUCTS ON PAGES 369-374

BACKING PADS



Orbital Sanding Pads - Hook Face

- High quality nylon hook face
- Weight-mated for perfect balance
- High quality premium urethane construction
- Fiberglass backing 100% inspected insuring the finest pad
- Top washer held to .0015" flatness-important for balance

DYB76011 - 5" Non-Vacuum

DYB76012 - 6" Vacuum

DYB76013 - 6" Non-Vacuum

DYB56206

6" Diameter Non-Vacuum Disc Pad, Vinyl-Face

- 3/8" thickness, urethane, medium density, 5/16"-24 male thread
- Weight mated- for smooth running and minimal tool vibration
- Ideal for PSA-type disc adhesion; remove abrasive adhesive paper liner and press abrasive to vinyl face sanding pad



DYB92255

4" Diameter x 1-1/4" Wide RED-TRED Eraser Wheel

- Eraser wheel only; no hub included
- Outstanding for removal of graphics, decals and two-sided adhesive tapes
- Eraser wheel has serrations for improved cooling effect air flow
- Also resists heat build-up and reduces jumping and vibration



NOR60605

Norton Multi Air Speedgrip Soft Orange 6 in. Bu Pad

- Innovative design for optimal air flow and powerful dust extraction
- Medium pad is recommended for all applications. Soft pad is only for applications of extreme contours using Speed-Grip P320 and fine
- Dimensions: 6.25" L x 6.25" W x 1.5" H
- 1 year warranty on material and workmanship



EEZ6636

6" PSA Epoxy-Fiberglass Sanding Pad

- Universal orbital sander replacement pad
- Industry's strongest 6 rivet arbor system
- Fully molded tapered edge
- Satisfaction guaranteed



HUT5003

Replacement Pads

- Straightline and Model 800
- Laminated high-grade rubber face
- Tempered aluminum base
- Standard for straightline models

HUT754

2-3/4" x 5 1/2" PSA Pad



- ProFinisher Orbital replacement pad
- Fits models 504/505
- Uses standard 2 3/4" sandpaper rolls



HUT740

2-3/4" x 4" PSA Pad



- Fits Models 504/505
- Uses Standard 2 3/4" sandpaper rolls



KT185811

Aluminum Pad Assembly - Jitterbug

- Replacement aluminum pad assembly, 2-2/3" x 9", for Jitterbug sander, model 85866



⚠ WARNING: Cancer and Reproductive Harm - www.P65Warnings.ca.gov



MMM20427

Hookit™ Clean Sanding Disc Pad Kit, 3" x 1/2"

- Dust extraction Hookit™ back up pad (clean sanding) is constructed on foam material



Back up pad itself has a 5/16-24 internal thread, and the kit includes 5 adapters that convert it to 1/4-20 external threads, 1/4-20 internal threads, 1/4-28 external threads, 5/16-24 external threads, or 6mm-1.0 external threads.

MMM5717

3M™ Hookit™ Backup Pad, 7" x 3/4", 5/8" - 11

- System provides a quick change advantage yet produces exceptional finishes on today's paints
- You get easy attachment, quick removal and accurate centering of either the compounding or polishing pad with the Hookit™ attachment system
- Centers compounding or polishing pads with accuracy
- Supports single-sided compounding or polishing pads



BACKING PADS

3M

3M™ Stikit™ Disc Pads

- The vinyl pad face provides good disc adhesion yet allows easy disc removal
- Lightweight, shock resistant and well balanced
- Max operating speed: 7,000 RPM



MMM5575 - 5"

MMM5576 - 6"

3M

MMM5777 3M™ Hookit™ Soft Interface Pad, 6" x 1/2" x 3/4"

- Designed for 3M™ Hookit™ abrasives
- Improves abrasive cut and finish
- Reduces vibration on dual action random orbital sanders using 3M™ Hookit™ disc pads
- For use with all 3M™ Hookit™ disc pads

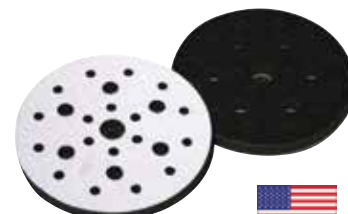

SANDING PADS



IRT315-39

Straight Line Sanding Pad for use with IRT315

- Specifically engineered to work at the tolerances of our Ingersoll Rand Tools, ensuring best finish possible



KT185004

4-1/2" Replacement Pad for High Speed

- Replacement backing pad for high speed sander, model 85265

⚠ WARNING: Cancer and Reproductive Harm - www.P65Warnings.ca.gov



KT185005

5" Replacement Pad for High Speed

- Replacement backing pad for high speed sander, model 85265,

⚠ WARNING: Cancer and Reproductive Harm - www.P65Warnings.ca.gov



KT185006

3 Piece Pad Set for DA Sander

- Replacement backing pad set
- Includes sizes: 3", 4-1/2", 5" diameter, for high speed sander, model 85265

⚠ WARNING: Cancer and Reproductive Harm - www.P65Warnings.ca.gov



MEGE7200

5-1/2" Sanding Backing Pad

- Evenly distributes hand pressure across face of finishing paper
- Closed cell construction makes it durable yet flexible
- Easy to use on flat or curved surfaces
- Use as a squeegee to dry surface after wet sanding



3M

Hookit Purple 6" Dust-Free Finishing Film Disc

- Long-lasting abrasive disc produces easy-to-polish finish
- Specially formulated coating reduces pigtailed and boosts abrasive life
- Flexible, durable film backing increases conformability
- Several hole designs available for better dust extraction
- Hookit™ attachment system makes for fast, efficient disc change-outs

MMM30770 - P800 Grit

MMM30771 - P600 Grit



MMM5530

3M™ Stikit™ Soft Hand Pad 2-3/4" x 5-1/2" x 3/8" - 1 Pad

- For use with Stikit™ Sheet rolls and Imperial color sanding paper sheets
- This pad provides a soft controlled touch
- Eliminates finger marks and edge cutting into primer and paint
- Ideal for contour and light scuff sanding



SANDING PADS



MTN6906 Professional Dual Action Random Orbital Sanding Pad with Self-Adhesive Backing

- 6" in diameter with 6 mounting holes
- Fits all popular dual action sanders with 5 or 6 mounting holes
- Maximum operating speed: 10,000 RPM

⚠ WARNING: Cancer and Reproductive Harm - www.P65Warnings.ca.gov

NIB FILES



STC35250 Spec-Out Nib File - Coarse

- Removes runs and dirt nibs
- Honed tips of teeth shave without digging in



STC35260 Spec-Out Nib File - Fine

- Removes runs and dirt nibs
- Honed tips of teeth shave without digging in

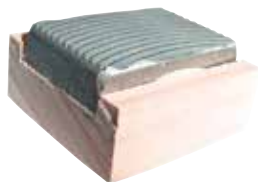
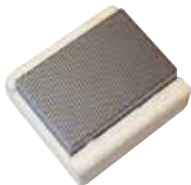

SGT89780 Coarse Nib File

- Removes imperfections on paint jobs, such as dirt and runs, without re-spraying
- High quality, precision ground files assure uniform results without gouging
- Easy to use - requires no special skill
- Works on both primer coats and top coats
- Use for heavy imperfections
- For use on dry paint surfaces only

⚠ WARNING: Cancer and Reproductive Harm - www.P65Warnings.ca.gov

SGT89790 Fine Nib File

⚠ WARNING: Cancer and Reproductive Harm - www.P65Warnings.ca.gov



ERASER PAD TOOLS



AST232 ONYX Pinstripe Removal Kit

- Specialty tool developed for the removal of pinstripes, adhesives, double faced tapes and moldings with ASTRO'S Smart Eraser® Pads
- 12 piece Smart Eraser Pads - 4" pads made of molded rubber with 5/16" arbor
- Patented

⚠ WARNING: Cancer and Reproductive Harm - www.P65Warnings.ca.gov



AST203 Pinstripe Removal Tool

- Specialty tool developed for the removal of pinstripes, adhesives, double faced tapes and moldings with ASTRO'S Smart Eraser® Pads
- Tool includes built-in regulator
- 4,000 Max. RPM
- Spanner wrenches included for easy removal of pad

⚠ WARNING: Cancer and Reproductive Harm - www.P65Warnings.ca.gov

AST400E 4" Smart Eraser Pad For Pinstripe Removal Tool

- For use with Astro model 533ET or 203
- Use with maximum rated 4000 RPM tool
- Not for use with standard non-g geared die grinders

⚠ WARNING: Cancer and Reproductive Harm - www.P65Warnings.ca.gov



MTN246K Eraser Pad Tool Kit

- Reduces time spent on the removal of Pinstripes, Adhesive, Double Faced Tape and much more
- Set includes 12pc vanilla scented eraser pads and 2600 RPM Eraser Tool
- Air Inlet: 1/4 Inch- Hose Size 3/8"
- Average air consumption- 3.5 CFM
- 5/16" - 24 Threaded Arbor on Eraser Pads

⚠ WARNING: Cancer and Reproductive Harm - www.P65Warnings.ca.gov

ADHESIVES

3M



MMM8008

3M™ Super Weatherstrip Adhesive, 5 oz. Tube, Black

- A strong, flexible, rubbery adhesive that can withstand vibration, oil, grease and extreme temperature variations
- Can be used to bond automotive weatherstripping and is great adhesive for holding paper, cork, or rubber gaskets in place during installation
- Can be used to bond weatherstripping to car doors, trunks, T-tops, moon roofs and sun roofs provides the strength and rapid setting



MMM8011

3M™ Weatherstrip Adhesive, 5 oz. Tube, Black

- A black, fast drying adhesive used for bonding and sealing automotive weatherstripping
- High heat resistant adhesive that remains flexible and waterproof
- Excellent for bonding EPDM rubber
- Fast strength buildup and good creep resistance
- Bonds to a variety of rubbers, fabrics, and metal



MMM8001

Weatherstrip Adhesive, Yellow, 5 oz. Tube

- Strong, flexible, rubbery adhesive that can withstand vibration, oil, grease, and extreme temperature variations
- Bond weatherstripping to car doors, trunks, T-tops, moon roofs and sun roofs
- Excellent adhesive for holding paper, cork, or rubber gaskets in place during installation



MMM8061

3M™ Plastic and Emblem Adhesive, 5 oz. Tube

- Strong, quick-drying adhesive can be used for bonding plastic or metal emblems, interior rigid plastic, tall light lenses, vinyl side moldings or upholstery



MMM8069

3M™ Press-In-Place Emblem Adhesive, 2" x 12"

- Transfer adhesive allowing emblems with existing foam tape to be re-attached-No stringing or trimming needed
- Simply press emblem onto adhesive and place emblem on vehicle

3M

MMM30023

3M™ Aerosol Spray Adhesive, 16-1/4 oz

- High contact bond strength
- One-minute dry time
- Excellent for securing wood moldings to tables, cabinets, shelving and furniture. High temperature resistance adhesive formula up to 160 degrees



MMM8074

3M™ Spray Trim Adhesive, 16.8 oz

- Clear adhesive that is used for attaching lightweight trim material such as upholstery cloth and trunk liners to metal and other surfaces
- Mat be used to bond styrofoam
- Ideal for position bonding applications where mechanical fasteners will be used



MMM8088

3M™ General Trim Adhesive, 18.1 oz.

- Low VOC, clear, high strength adhesive for bonding automotive materials such as carpeting, jute pads, fabrics and plastics to metal and other surfaces
- Has good heat and water resistance



MMM8090

3M™ Super Trim Adhesive, Yellow, 19 oz.

- Aerosol contact adhesive designed for bonding vinyl tops, heavyweight liners and hood silencer pads where high strength and heat resistance are needed



MMM21210

Spray Adhesive Aerosol Can 24 Oz

- High tack and fast drying for permanently attaching foils, carpeting, lightweight foams, paper, cardboard, felt and cloth to painted or unpainted metals, wood and hardboard
- Aggressive tack provides high initial grab with enough time to position materials properly

MMM38987

3M™ Specialty Adhesive Remover - 15 oz.

- A VOC compliant (70%) solvent-based aerosol specialty adhesive remover
- Designed to remove reactive adhesives from a variety of substrates



ADHESIVES

3M



MMM8101

3M™ Structural Adhesive Kit

- Two part general purpose gray structural adhesive that may be used for bonding metal, glass and plastic
- This product can be used for trim, fiberglass, and flexible body parts repair
- Easy to mix, sets up quickly, spreads smoothly, and cures to an extremely strong bond
- Two 2 fluid oz. tubes per kit

MMM8115

3M™ Automix™ Panel Bonding Adhesive, 200 ml Cartridge



- Two part epoxy used to bond steel, aluminum, SMC, and FRP (traditional fiberglass)
- Primary use is to replace quarter panels, roofs, box sides, van sides, utility vehicle sides and door skins
- Cures on demand with addition of heat
- Glass beads work as built in spacers for optimum bond line thickness product has corrosion inhibiting ability



MMM8239

3M™ TPO Plastic Parts Repair, 200 ml Cartridge



- Two-part urethane used to repair thermoplastic polyolefins (TPO) such as PP, PE, and EPDM
- Used to repair gouges and small nicks on bumper fascia and other plastic parts
- Excellent choice for nicks, gouges or small defects on mentioned plastics due to extremely fast work time
- Excellent flexibility over a wide range of temperatures



MMM8609

3M™ Window-Weld™ Super Fast Urethane, Black, 10.5 Fl. Oz Cartridge

- One part moisture curing urethane adhesive that bonds auto replacement glass to car bodies

3M



MMM8641

3M™ Automix™ Channel Bonding and Sidelite Adhesive, 2 oz.

- Black, flexible and durable adhesive used for bonding moveable and stationary glass into place
- Has a 4 to 5 minute worklife and drive-away time of one hour
- Dispense with 3M™ Automix™ Applicator Gun, part number 08191, and 3M™ Automix™ Mixing Nozzles, part number 08197



MMM8661

3M™ Super Silicone Seal, Clear, 3 oz. Tube

- A paste-like, one-component clear material which cures to a tough, rubbery solid when exposed to moisture in the air
- It will adhere to clean metal, glass, wood, ceramic, natural and synthetic fiber, painted surfaces and many plastics
- Excellent for general purpose bonding and sealing, as well as formed in place gasketing applications

MMM8155

3M™ Quick Fix Adhesive, 1 oz. Bottle

- Has good adhesion to rubber weatherstripping, vinyl, metal, glass, side moldings, emblems, trim pieces, and most plastics
- Excellent resistance to temperature extremes, shock, and most automotive and marine fluids



MMM8987

General Purpose Adhesive Cleaner - 15 oz.

- Specially blended solvent for removal of light paint overspray, adhesive residue, wax, grease, tree sap, dirt, road tar, oil and bugs in aerosol form



ADHESIVES

3M

MMM4240 3M™ Duramix™ Plastic Repair Semi-Rigid

- Urethane plastic repair material for repairing damaged bumpers and re-building tabs
- Can also be used to bond many dissimilar materials such as plastic, fiberglass and metal



MMM4247 3M™ Duramix™ Super Fast Repair Adhesive - 200 ml.

- 20 second set urethane adhesive that replaces cyanoacrylates
- Will not crack or become brittle like cyanoacrylates
- Bonds to virtually any substrate and has excellent gap filling capabilities for bonding small parts
- Excellent for rebuilding cracked eyelets and broken tabs



MMM4747 Duramix Super Fast Adhesive - 50cc

- Substrates: aluminum, steel, brass, copper, rubber, plastics, PVC, ABS, polycarbonate, acrylic, fiber reinforced polyester
- Temp range: -40 to 176° F
- Viscosity: 1000 to 2000
- Tensile strength: 1500 to 2000 PSI



MMM38191 3M Static Mixing Nozzle, 50mL, 12 Nozzles Per Bag

- 3M Static Mixing Nozzle is a cascade mix/meter nozzle for an easy squeeze of adhesive right on target
- Engineered for use with 3M 50mL cartridges
- Efficiently mixes a variety of 3M two component adhesives, sealers and foams
- 6 Bags Per Case



MMM8193 3M™ Automix™ Mixing Nozzle (6 Nozzles per Bag)

- Designed for use with the 200 ml cartridges
- Larger diameter allows for easier dispensing
- Nozzle can be used with Automix™ products in the MixPac® Applicator Guns 08117 or 09930



SEM

SEM39337 Non-Sag SMC Structural Adhesive

- Bonds SMC to SMC and metal space frames
- 7oz. cartridge



Dual-Mix multipurpose adhesives, fillers and sealers are the first choice for body shops nationwide. These products are essential in a growing number of automotive procedures, including the repair of plastic parts.

WARNING: Cancer and Reproductive Harm - www.P65Warnings.ca.gov

SEM39747 Multi-Purpose Panel Adhesive

- 7 oz. cartridge



SEM39757 Dual Mix Impact Resistant Adhesive

- OEM recommended
- 60 minute working time
- Superior impact and peel strength
- Excellent corrosion resistance
- Minimized down times with multiple heat cure options

WARNING: Cancer and Reproductive Harm - www.P65Warnings.ca.gov



MAR20382 Mixing Board 100 10 in. x 13 in. Sheets

- Offers a clean surface for mixing body filler
- Disposable for easy clean up
- Use to mix body fillers, resin, compounds and gel
- Designed to resist penetration



GERSON®

GRS010714R 226 Micron Orange Mesh 1 Case

- "No touch" contamination-free storage and dispensing of strainers
- Pre-packed pods load directly into Elite Dispenser
- Automated production with triple-cleaned mesh assures highest level of filter purity
- Color-coded filter for easy identification of micron size
- Lifetime warranty does not cover abuse



CHAINS

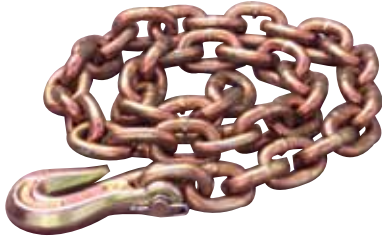

MOC6006

3/8" x 6' Frame Chain™

- Made of heat treated steel
- Protectively plated with yellow dichromate
- #6210 3/8" Alloy Clevis Grab Hook included
- Working load limit: 6,600 lbs.
- Manufactured in accordance with the NACM specification for chain, ASTM standard A391 and ASTM standard A413 for grade 70 carbon steel chain

MOC6008

3/8" x 8' Frame Chain™

MOC6010

3/8" X 10' Frame Straightening Chain



MOC6311

Ford "T" Hook™ with 3/8" Chain

- Original shipping tie down for Ford vehicles
- Excellent around the frame machine to help hold a frame while diamond is being pulled

Specs:

- Overall Length: 12" (305mm)
- Weight: 2 lbs (.91kg)
- Capacity: 5 tons (4,536kg)

MOC6317

"J" Hook with Chain

- Original shipping tie down for all vehicles
- Excellent around the frame machine to help hold a frame while diamond is being pulled
- Heat-treated steel
- Lifetime warranty

Specs:

- Overall Length: 6" (228mm)
- Weight: 2 lbs (.91kg)

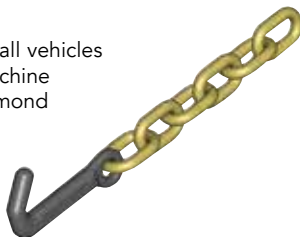

SLINGS

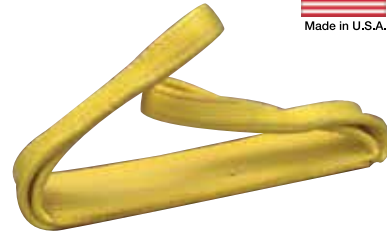

MOC6300

Nylon Sling™

- Made of durable nylon
- 30" long and can be made into a cinch
- Protects area where chain may damage structure
- Weight: 1 lb.; Vertical capacity: 2.5 tons

Specs:

- Overall Length: 30" (762mm)
- Weight: 1 lb (.45kg)
- Vertical Capacity: 2.5 tons (2,268kg)
- Choke Capacity: 2 tons (1,814kg)
- Basket Capacity: 5 tons (4,536kg)



MOC6301

Nylon Sling with Metal Triangles

- Overall Length: 20-1/2" (521mm)
- Width: 4" (102mm)
- Vertical Capacity: 1 ton (907kg)
- Choke Capacity: 1 ton (907kg)
- Basket Capacity: 2 tons (1,814kg)
- Heat Treated Steel



MOC6302

Sling with Pear and Triangle™

- Protects finish from mars
- Wraps around and protects pillars while spreading the force
- Forged pull loops for exceptional toughness
- Heat treated steel

Specs:

- Overall Length: 31" (790mm)
- Width: 4" (102mm)
- Weight: 4 lbs (1.81kg)
- Vertical Capacity: 2,400 lbs (1,088kg)
- Choke Capacity: 1,500 lbs (680kg)
- Basket Capacity: 2 tons (1,814kg)



BODY HAMMER SETS



KT170511
7 Piece Body and Fender Hammer Set

- Machined hammer heads
- Red fiberglass handles with comfort grips
- For pounding auto sheet metal before finishing
- Use on flat and curved surfaces
- Includes: bumping hammer, pick hammer, chisel end hammer, heel dolly, shrinking dolly, double end dolly, curve dolly

WARNING: Cancer and Reproductive Harm - www.P65Warnings.ca.gov



DENDF-HK111
Multi-Head Hammer Set

- Quick changing heads • 9 Interchangeable heads
- 3-head ring hammer included • Blow molded case
- Simplify your tool box



HSA7803
3 Piece Aluminum Hammer Set

- Hickory handle hammers
- The set includes pick, chisel and square-head hammers marked in red for easy identification
- 1 year warranty on material and workmanship



KDT82302
7 Piece Body Hammer Set

- Includes the most popular body tools for today's applications
- Forged and precision polished
- Wooden epoxy bonded handles provide accurate touch and feel of work
- Lifetime warranty

Contains smooth faced bumping hammer with square and round face, smooth faced cross chisel hammer, cross faced shrinking hammer, wedge dolly, general purpose dolly, toe dolly and heel dolly.



STC35000
Soft Strike Aluminum Conversion Kit, 4 Piece Set

- Apply our red rubber removable covers to the tools that you already own giving you the ability to work on aluminum with no worry of galvanic corrosion
- Soft Strike Rubber Dollie Body Covers and Soft Strike Dinging Spoon Cover are made from Buna rubber for your steel heel dolly and dinging spoon
- Soft Strike Hammer Cover is made from vinyl to allow you to easily transition from working body tools on steel to aluminum
- Soft Strike Dollie Cover also eliminates the problem of a rubber dolly not being heavy enough to work effectively by allowing you to simply add the cover to your existing steel dolly

BODY HAMMERS - BODY REPAIR

Martin



MRT647K
7 Piece Body and Fender Repair Set with Hickory Handles

- Includes a limited lifetime warranty
- All made with the quality and durability to last

This Martin set includes: cross chisel curved hammer, shrinking hammer, utility pick hammer, light dinging spoon, toe dolly block, heel dolly block and general purpose dolly block.



MRT694K
4 Piece Body Hammer Set

- Pick Hammer
- Curved Cross Chisel Hammer
- Utility Pick Hammer
- Door Skin Hammer



MRT155G
Fender Bumper with Hickory Handle

- For bumping where hand and dolly cannot reach
- Ample clearance for obstructions
- Also used as a caulking iron
- Length of head: 8-3/4"
- Weight: 2.8 lbs.

Martin



MRT644KFG
4 Piece Body and Fender Kit with Fiberglass Handles

- Pick Hammer - 1-1/2" diameter low crown round face for smoothing and stretching
- Curved Hammer - Used for prying and smoothing
- Dinging spoon - this spreads the blow over a large area making a smooth job and preventing damage to metal or the finish
- Dolly block - Excellent forming and caulking tool for the deep pockets of doors, quarter-panels, rear fenders and lower trunk panels
- Limited lifetime warranty



MRT647KFG
7 Piece Body and Fender Repair Set with Fiberglass Handles

- Includes a limited lifetime warranty



This Martin set includes: cross chisel curved hammer, shrinking hammer, utility pick hammer, light dinging spoon, toe dolly block, heel dolly block and general purpose dolly block. All made with the quality and durability to last.



MRT694KFG
4 Piece Fiberglass Body/Fender Repair Hammer set

- General purpose hammer, curved cross chisel hammer, doorskin hammer, and utility pick hammer.
- Forged 4140 hammer heads
- Superior weight to strength ratio

BODY HAMMERS

Martin



Type	Description	Wooden Handles	Fiberglass Handles
Dinging Hammer	For fender and high crowned panel dinging or bumping. Both high and low crown faces for "on or off dolly" work. Faces, 1-1/4" & 1-9/16". Round heads, 6" overall.		MRT150FG
Cross Chisel Hammer	Excellent for finishing. Cross peen used for working in sharp corners around mouldings and for caulking. Round face, 1-9/16" chisel, 3" long.		MRT153FG
Curved Cross Chisel Hammer	Excellent for finishing. Cross peen used for working in sharp corners around mouldings and for caulking. Well balanced curved chisel for work in close places. Round face, 1-9/16" chisel, 3" long.	MRT153GB	MRT153FGB
Vertical Chisel Hammer	Excellent for finishing. Cross peen used for working in sharp corners around mouldings and for caulking. Vertical chisel end used on sharp corners. Round face, 1-1/2", 5/8" chisel, 5-1/2" long.		MRT154FG
Vertical Chisel Shrinking Hammer	Cross grooved. Extra wide faces are cross grooved and used for shrinkage on large surfaces - vertical chisel end used on sharp corners. Round face, 1-1/2", chisel, 5-1/2" long.		MRT154SFG
Pick Hammer	Long reach, thin point for low spot on low crown panels. Reaches over inner obstructions. One high crown face. Face, 1-1/4" round point, 1/32" radius. Length of pointed end, 5-1/2".		MRT156FG
General Purpose Pick Hammer	Medium size point and reach for general work. Low crown strawberry point for perfect balance. Face, 1-9/16" round point, 3/32" radius. Length of pick end, 3-3/4".		MRT158FG
Shrinking Hammer	For work in close corners. Expertly machined serrations on the round face. Plain square face, 1-1/8" round serrated face, 1-1/4" diameter. 4" overall.		MRT162FG
Utility Pick Hammer	Blunt point, short reach. For low spots in high crown panels and other work with small clearance. Face, 1-9/16" round point, 5/32" radius. Length of pointed end, 2". 4" overall.		MRT164FG
Cross Peen Finishing Hammer	Used to bump odd fender or bumper contours. Round face, 1-9/16" diameter peen end 3/16" x 7/8". 5" overall head length. 12" handle.		MRT168FG
Finishing Hammer	end 3/16" x 7/8". 5" overall head length. 12" handle.		MRT168FG
Door Skin Hammer	For high crown work and finishing, without poking holes in thin sections. 6-1/2" overall length. 12" handle.		MRT170FG
Replacement Handles	Hickory handle for body hammers (except 155G fender bumper & 165G pick hammer)	MRTHH42B	

WARNING: Cancer and Reproductive Harm - www.P65Warnings.ca.gov

BODY HAMMERS



SGT89360

5 Piece Body Forming Punch Set

- Innovative unique one-of-a-kind set
- 5 profiles to fit the specific job
- Use to form curves, contours, radiuses and body panels in hard to reach areas
- Polished and hardened surfaces to form sheet metal with precision
- Each Punch is 12" overall length

WARNING: Cancer and Reproductive Harm - www.P65Warnings.ca.gov



SGT89470

9 Piece Body Repair Kit (Blue for Steel)

- Highly polished dollies and hammer heads with Hickory handles for the hammers
- Versatile design for a variety of applications
- Supplied in a blow molded case

Kit includes: Universal Dolly, Toe Dolly, Heel Dolly, Pick & Finishing Hammer, Chisel & Finishing Hammer, Heavy Bumping & Finishing Hammer, Door Skin Hammer, General Purpose Spoon, Light Slapping Spoon

WARNING: Cancer and Reproductive Harm - www.P65Warnings.ca.gov

SGT89450

9 Piece (Red for Aluminum) Body Repair Kit

- Forged steel
- Versatile design for a variety of applications
- Highly polished hammer heads and dollies
- Hickory hammer handles
- Pieces painted red for identification
- Supplied in a blow molded case

Set includes: Universal Dolly, Toe Dolly, Heel Dolly, Pick & Finishing Hammer, Chisel & Finishing Hammer, Heavy Bumping & Finishing Hammer, General Purpose Spoon and Light Slapping Spoon

WARNING: Cancer and Reproductive Harm - www.P65Warnings.ca.gov



BODY SPOONS



ALC55115 Shot Dolly

- Heavy duty leather pouch filled with 2-1/2 lbs. of shot
- 2-3/4" W x 6" L

WARNING: Cancer and Reproductive Harm - www.P65Warnings.ca.gov



ALC55116 Rubber Heel Dolly

- Ideal shape for door skin work, moves the metal rather than stretching it
- Rubber coating provides cushioning effect, Weighted hard rubber to match weight of hammer
- Works easily in sharp corners & wide radii, Also works well on newer, thinner sheet metal



WARNING: Cancer and Reproductive Harm - www.P65Warnings.ca.gov



ALC55120 Large Rubber Dolly

- Absorbs the hammer shock and reduces stretching of sheet metal
- It also reduces hand fatigue
- 5" L x 3" W x 1-1/2" H; weight: 1 lb. 8 oz.

WARNING: Cancer and Reproductive Harm - www.P65Warnings.ca.gov



BODY SPOONS



ALC77505

Medium Second Cut Slapping File

- Ideal for panel shrinking and metal removal
- Shaped for easy hand use
- Fully heat treated



WARNING: Cancer and Reproductive Harm - www.P65Warnings.ca.gov



ALC77506

Coarse Bastard Cut Slapping File

- Ideal for panel shrinking and metal removal
- Shaped for easy hand use
- Fully heat treated



WARNING: Cancer and Reproductive Harm - www.P65Warnings.ca.gov

Martin



MRT1024

Surfacing Spoon

- Excellent spoon for fender spring hammering, finishing and shaping
- Curve gets behind inner construction between panels that are close for removal of dents
- Molds panels
- Blade is fully polished
- 9" blade length; 2-1/2" width; overall length: 15-1/2"; weight: 2.5 lbs.



MRT1052

Spoon Dolly

- Face size: 2-1/2" x 1" x 3"
- Long handle that permits many uses in places otherwise inaccessible
- Can be driven between reinforcements and outer panel, then used to pry outward as the metal is dinged
- Excellent forming and caulking tool for the deep pockets of doors, quarter-panels, rear fenders and lower trunk panels



Martin



MRT1054

Long Curved Spoon

- Face: 2" x 7"
- Length: 10-1/2" overall
- Used to pry up dents behind curved reinforcements
- Long, thin, curved blade is handy for prying up dents behind curved reinforcements in header panels, hinge anchors in doors, body pillars and reinforcements in hoods and radiator shells. Made with quality and the durability to last!



MRT1056

Wing-Ding Spoon Dolly

- 1" handle diameter, 19" length
- Used for tight, crimped areas
- Wide spoon spreads the blow over a wide area without damage



The answer to repair problems on high fins. A dolly, a spoon, a pry. It's long handle and special contours are for working up inside cramped fins. Wide spoon transmits-hammer blows over wide area without damaging the finish.



MRT1036

Light Dinging Spoon

- Face: 2" x 4-5/16"
- Length: 10"
- Used to ding ridges smooth and level
- Not used for prying
- When held against ridge and struck with hammer, this spreads the blow over a large area making a smooth job and preventing damage to metal or the finish



MRT1057

Light Weight Toe Dolly

- 4-3/4" x 2-1/4" x 11/16"
- Designed for flat surfaces
- Used in shrinking and dinging flat panels



Thinness and length provide easy accessibility to narrow pockets. Large, flat face is frequently used in shrinking and dinging flat panels. The flat sides furnish a convenient anvil for repairing flanges. Also it's light in weight for the flat surfaces.

BODY SPOONS

Martin

**MRT1058
Toe Dolly**



- Thinness and length provide easy accessibility to narrow pockets
- Large, flat face is frequently used in shrinking and dinging flat panels
- The flat sides furnish a convenient anvil for repairing flanges
- 4-3/4" x 2-3/8" x 1-1/8"

**MRT1058S
Toe Dolly**



- Shaped like a toe dolly, but has one face covered with raised serrations
- The serrated side is used for shrinking metal stretched by dents

Thinness and length provide easy accessibility to narrow pockets. Large, flat face is frequently used in shrinking and dinging flat panels. The flat sides furnish a convenient anvil for repairing flanges.



**MRT1059
Heel Dolly**

- 3-1/8" x 1-3/8" x 2-1/4"
- Made of drop-forged steel
- Used for corner and wide radii areas



The design of the heel dolly makes it possible to reach easily into sharp corners and wide radii. These features are exclusive to the heel dolly and continues for the high demand. Made with the quality and durability needed to last!

Martin

**MRT1060
General Purpose Dolly**



- 2-7/8" x 2-3/8" x 2.25"
- General purpose dolly ideal for shaping and molding metal
- Several differently crowned working faces

Provides convenient and comfortable hand hold during heaviest blows. The weight, balance and several differently crowned working faces, together with two beading and flange lips, give this dolly a broad general use!



**MRT645K
Spoon/Dolly Set - 4 Piece**

- Includes Light Dinging Spoon, Toe Dolly, Heel Dolly and All Purpose Dolly

PAINT & BODY | tools

PAINTLESS DENT REMOVAL TOOLS



**DENDF-DM555UDX
Ultra Ding Massager**

- Glue pullers are an excellent method for removing dings and small dents from OEM paint
- New! T-Puller
- New! Knock down tool with 2 heads
- New! 6 Piece hard plastic knockdown and shaping tools
- New! 24 Different Pulling Nibs - The new and redesigned pulling tabs provide the technician with more choices and nib surfaces for better fitment which improves grip when repairing the many varieties of dings and minor dents from small to large
- Squeeze Puller - allows for a massaging action that helps release the tension in the metal, allowing for a quicker more successful pull. The squeezed position holding capabilities allow for a constant pull



PAINTLESS DENT REMOVAL TOOLS



DENDFMP050K

5 in 1 Pneumatic Punch and Flange Kit

- Unique design of the cutter shears the metal rather than forcing it's way through like other flat head cutters
- This shearing action creates no distortion and extended life of the tool and cutters
- Hole punch sizes are 4.0mm, 5.5mm, 6.5mm and 8.0mm
- The included flanging head is 1" wide



DENDF8

1/4" Hole Punch

- With the one and one quarter inch deep throat you will be able to get the best overlap capability for your plug welds
- Generic Dimensions: -1/4" Hole Punch
- Dimensions: Overall Height - Top to Bottom: -1.3 Inches. Overall Width - Side to Side: -5.8 Inches. Overall Depth - Front to Back: -11 Inches.



DENDF-505BP

Steel Bridge Puller

- Intended to be used with the Maxi or Aluspot
- Customizable & adjustable
- Can hold pull in place
- Other accessories may need to be purchased separately
- Simple one-man operation

DENDF-505DM

Maxi Massager

- Add-on for the DF-505 Maxi
- Adjustable depth
- Fine finish work
- Weld rod slides in easily
- Massage steel pulls



ALC77003

11 Piece Heavy Duty Push-Pull Body Mate Jack Set

- A compact and powerful jack set for use in those knuckle booting areas
- Designed for pushes and pulls of front end work, roof bracing, rails and bumper alignment
- Universal application allows it to be used anywhere on the car
- All friction rod and jack parts are hardened steel
- All attachments are fully plated

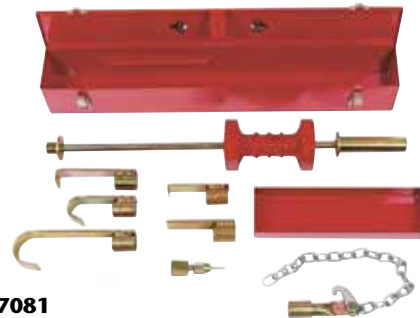

ALC77081

Dent Puller Kit

- The highest quality 12lb dent puller available; More exclusive features than any dent puller anywhere
- Square slide hammer does not roll away out of reach; Solid 5/8" high carbon steel slide shaft is the strongest offered anywhere
- All attachments are heat treated and plated for strength and a lasting finish



WARNING: Cancer and Reproductive Harm - www.P65Warnings.ca.gov

ALC77043

Monkey-On-A-Stick Jack Set

- 55" long solid alloy 3/4" rod eliminates need for extension tubes
- Up to 3,000 lbs. push/pull power
- Multiple position handle for hard to reach areas
- Friction jack features 5 hardened friction plates f or minute adjustments



ALC77175

The Hustler Stick Alignment Bar

- Heavy duty 1-1/4" diameter tubing with two welded hooks for strength and versatility
- 1/4" chain, 6' long, hooks on both ends



WARNING: Cancer and Reproductive Harm - www.P65Warnings.ca.gov

PAINTLESS DENT REMOVAL TOOLS



**HSA7570
PDR Glue Pulling Kit**

- Professional glue dent pulling system
- Paintless dent removal for steel and aluminum panels
- Features anodized aluminum squeeze puller and slide hammer, glue gun and pull knobs
- Includes high-strength platinum glue that can be used with steel pull tabs



**HSA7700
Uni-Vac Dent Puller**

- Quality machined vacuum operated dent puller with no external air lines required
- Vacuum operated suction
- Durable storage case
- Works on steel, aluminum panels & bumpers
- Can be used in shop or outside locations
- Comes with three different sized vacuum cups and a durable storage case
- Can be used anywhere: inside a shop or outside on a lot
- Quick and easy approach to dent repair



**HSA1091
Uni-Bridge Quick Pull 12"**

- 12" Bridge for aluminum or steel dent pulling
- Attaches to pulling rods (UNI-1065) or tabs directly in order to pull the dent
- 1 year warranty on material and workmanship



**HSA1092
Uni-Bridge Standard Pull 34"**

- 34" bridge for aluminum or steel dent pulling
- Standard pull
- Single column design
- Attaches to pulling rods (UNI-1065) or tabs in order to pull the dent
- 1 year warranty on material and workmanship



**HSA1093
Uni-Bridge Extended Pull 49"**

- 49" bridge for aluminum or steel dent pulling
- Extended pull
- Double column design
- Attaches to pulling rods (UNI-1065) or tabs directly in order to pull dents
- 1 year warranty on material and workmanship



**LTILT800
2 Piece Inflatable Dent Remover**

- Uses hand pumped air pressure to push dents out from the inside of door and fender panels
- Comes in 2 sizes: The LT805 8" x 8" Square Inflatable Dent Remover is for removing dents in tight corners or along welded seams and panel edges
- The LT810 14" x 8" Oblong Inflatable Dent Remover is for longer more accessible large dents
- Each bag has 5' of air hose with oversize hand pump bulb for long reach
- Perfect for paintless auto body repair

PAINTLESS DENT REMOVAL TOOLS

OTC



OTC1177

5 Lb. Reversible-Jaw Slide Hammer Puller

- The basic slide hammer unit can be removed and used independently
- This puller with a 5 lb. hammer, 2-way and 3-way head is 27" in length
- The inside 2-jaw spread minimum 1-1/4" to the maximum 3-1/2" and the outside minimum 1" to the maximum 4-1/2"
- The inside 3-jaw spread minimum 1-1/2" to the maximum 4-1/4" and the outside minimum 1-1/2" to the maximum 4-1/2"



OTC898A

Body and Fender Dent Puller

- 17" long • Pyralin handle grip
- Removes dents without removing the interior panels and upholstery - simply drill a hole at the base of the dent and thread in the tool's self-tapping screw and a few sharp blows of the slide hammer will pull the dent out
- Replaceable self-tapping screw



OTC4581

Stinger Slide Hammer Blind Hole Bearing Puller Set

- For pulling jobs requiring an internal pull, such as pilot bearings
- Set includes four collets which fit a wide range of applications
- Set includes a 2-1/2 lb. slide hammer with T-handle
- Housed in a blow-molded plastic storage case

Includes four collet sizes: 3/8" to 1/2", 9/16" to 11/16", 5/8" to 1", 1" to 1-1/4". When using select the appropriate sized collet by comparing it with the application. Insert the collet, expand it to fit the hole, then attach the slide hammer assembly.

TOOL AID TOOL AID®



SGT81000

The Slugger, Heavy Duty Slide Hammer

- Perfectly designed for the toughest repair applications
- 10 lb. slide weight designed for in-line impact
- Balanced for continued use without fatigue
- Special hand-fit weight for ease of work
- Dual hammer action for reverse or direct reconstruction blows
- Packaged in a metal storage case

WARNING: Cancer and Reproductive Harm - www.P65Warnings.ca.gov



SGT81500

Junior Slugger Slide Hammer Dent Puller

- The finest shop engineered heavy duty slide hammer with 3 lb. slide weight
- Features a soft vinyl "Hang-It" handle grip for easy storage and shock cushioning
- Special wide aircraft steel body hook is used to pull curls and creases in quarter, rocker, back and door panels
- "L" hook, broached nose cone, two jam nuts and two hardened pulling screws are supplied

WARNING: Cancer and Reproductive Harm - www.P65Warnings.ca.gov

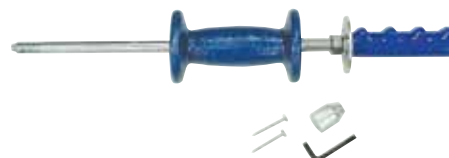

SGT81400

Dent Puller and Slide Hammer

- 3 lb. slide weight is mounted on 1/2" plated steel shaft
- Famous blue vinyl hand grip over steel handle reduces sting on technician's hands and provides 100% grip
- Broached hex in nose cone locks pulling screw in place...ends breakage
- Supplied with two hardened pulling screws and "L" puller hook fabricated of aircraft quality steel
- Nose cone and shaft threads are 1/2" - 20

WARNING: Cancer and Reproductive Harm - www.P65Warnings.ca.gov

STUD WELDER KITS



HSA9540

Auto Pro Steel Welding System Package

- Steel Dent Repair System
- Welds steel studs, tabs, wire, and weld on slide hammer for dent repair
- Comes with cart, tab shooter, and lever puller for easy repair
- Pull dents faster than ever with the tab shooter and tabs
- More options, power, and control than other systems for a lower price
- The ultimate dent repair system for steel repair. With the use of the tab shooter, tabs, and lever puller you can now pull a dent in minutes for what used to take hours!
- 1 year warranty on material and workmanship



HSA9700

Dual-Spotter Deluxe Alum/Steel Stud Welder

- Hand held alum/steel stud welder
- Adjustable output power
- Digital controls
- Includes stud welder, power supply, ground cables, weld tips
- Heavy duty ABS carrying case
- 1 year warranty on material and workmanship



HSA9500

Multifunction Steel Stud Welder

- Multifunction dent pulling system for steel
- Offers timed, pulsed, or automatic mode
- Four timer and four power settings to set pull pins, pull tabs, wiggle wire, shrink tip or weld-tips
- System includes extended cables, weld-tip ground, stud, tab shrink and wire tips, stud pins, tabs, wire and weld-tip slide hammer
- 1 year warranty on material and workmanship



HSA9800

Dual-Pro Aluminum and Steel Stud System

- Multifunction dent pulling system for aluminum and steel panels
- Two torch cables (one for steel; one for aluminum)
- Weld studs, tabs, wiggle wire, and shrink tips
- Professional multifunction dent pulling system for aluminum and steel panels. Simply select STEEL or ALUMINUM mode and adjust setting for AL studs (4mm or 6mm), pull pins, pull tabs, wiggle wire, shrink tip or weld-tip. System features plug-in extended torch cables for ease of operation, stud, tab, wire and shrink tips, assorted pins, tabs, wire and rods with weld-tip slide hammer
- 3 year warranty on material and workmanship

STUD WELDER KITS



HSA9000

Uni-Spotter Deluxe Stud Welder Kit

- Superior stud welding kit for the professional body man who wants the best
- The most powerful transformer on the market and will keep operating efficiently in all kinds of high-demand situations such as multiple users or low voltage source found on the end of a long extension cord
- Features the Uni-Spotter exclusive "Stud Ease Technology"

The Uni-Spotter 9000 Deluxe Kit contains: 9090-Uni-Spotter Deluxe Gun, 1016-Deluxe Slidehammer, 1095-Mini Puller, 1040-eliminator side-by-side adaptor with extend-a-tip, 1001-2.2mm flexpert welding studs, 1002-2.6mm heavy weight welding studs, 1003-mold rivets, Stud welding tip, 1005-mold rivet tip, 1007-shrink tip and 5529 custom molded toolbox



HSA5500

Uni-Spotter Stinger Plus Stud Starter Welding Kit

- Complete mid-range kit, featuring the most powerful mid-range welder available
- Features the Uni-Spotter exclusive "Stud Ease Technology"
- 2 Year Limited Warranty

Kit Includes: 5590 Stud Gun, 1016 Deluxe Slide hammer, 1004 Stud tip, 1005 Mold Rivet Tip, 1007 Shrink Tip, 1040 Eliminator, 1095 Mini Puller, 1000 Blackhead Studs, 1001 Flexpert Studs and 1003 Mold Rivets



HSA4550

Starter Kit Plus Stud Welder Kit

- The most powerful lightweight stud gun available
- Super sensitive trigger in handle for one-handed operation
- Built in overload protection
- Exclusive Stud Ease Technology
- Upgraded 1016 "T" handle slide hammer

The Starter Kit Plus has Stud Ease Technology which holds stud in welder for easy out of position welding. Welds studs easier and faster. Includes package of 500 Flexport welding studs. 2 year limited warranty; lifetime transformer warranty.



KILART500

Aluminum and Steel Stud Welder

- Rolls easily around shop environment on 8 inch rubber wheels
- Welds 4mm and 6mm aluminum and steel studs
- Quality construction built in Sacramento California
- 1 year warranty on material and workmanship

SPOT WELD CUTTERS



ALC77419

4 Piece Cobalt Spot Weld Cutter Set

- Cuts 5 times faster than hole saw cutters
- Made from the Superalloy, Cobalt
- Packaged in an attractive cherrywood box
- Lifetime warranty

⚠️ **WARNING:** Cancer and Reproductive Harm - www.P65Warnings.ca.gov



ALC77778

4 Piece Spotweld Cutter Set

- Use in either an electric or pneumatic drill
- Leaves a clean hole that requires very little grinding
- Self centering point minimizes walking, will not require a punch
- Solid one piece construction will not break or snap

⚠️ **WARNING:** Cancer and Reproductive Harm - www.P65Warnings.ca.gov



WELDING STUDS



HSA1001

The "Flexpert" Welding Stud 500/Box

- Flexpert Uni-Spotter Welding Stud S2.2mm, for regular sheet metal damage
- Special 5 process alloy for super flexibility
- For hard-to-reach and compound pulls
- 500 lbs. fusion strength with 1500 lbs. tensile strength

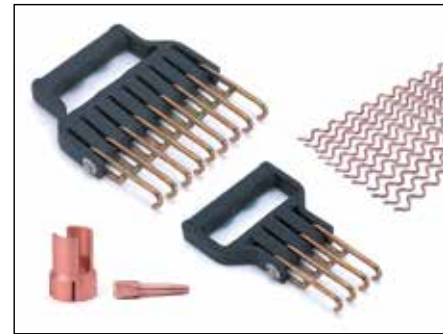

HSA2120

Uni-Wire Kit

- The most complete Uni-Wire Kit available
- Fits any Uni-Spotter Model Welder
- Kit includes the Uni-Wire Tip and adapter, both the 4 finger and 9 finger uni-claw to handle any pull, and a 1/2 lb. bundle of premium quality Uni-Wire

HSA1002

The "Heavyweight" Welding Stud 500/Box

- Heavy weight Uni-Spotter Welding Stud S2.6mm, the heaviest stud available
- Specially designed for heavy hit areas
- Ideal for rockers, rails and door posts
- 500 lbs. fusion strength with 2000 lbs. tensile strength



HSA1045

Eliminator Side-by-Side Adapter Kit with Stud Ease Technology

- Holds stud in place for easy out-of-position welding
- Welds studs easier and faster, increase accuracy when pulling small studs
- Exclusive to the Uni-Spotter Stud Welder
- Patent pending

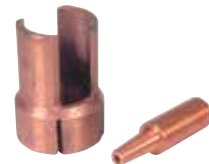

HSA1004

Stud Welding Tip for all Guns

- Can be used with all welding studs up to 2.6mm in diameter
- Designed with a Morse Taper for positive fit with an easy removal



HSA1007

Shrink Welding Tip

- The slightly convex design applies heat to the panel without burning
- Great for use when shrinking panels in replacement of an oxy-acetylene torch
- Designed with a Morse Taper for a positive fit with an easy removal



HSA2101

1 lb. Uni-Wire Bundle

PULLING TABS & STUDS



DENDF-503KEM Magnetic Key Tip

- Weld keys for use with bridge puller
- Includes key tip & sample keys
- Use with the Maxi (DF-505)

DENDF-503KF 100 Piece Weld Key Straight

- Weld keys to be used with key style pulling
- Straight shaft



DENDF-503KT 100 Piece Weld Key Twister

- Weld keys to be used with key style pulling
- Twisted shaft



HSA9600 Tab Shooter

- Allows you to weld tabs faster than ever before
- Holds 30-40 tabs
- Works with 9700, 9500, 9800



HSA1063 Uni-Tab Adapter for Stud Guns

- Steel use only
- Utilize tabs for pulling dents
- Use with UNI-1061, UNI-1062 tabs
- Adapter for UNI-4550, UNI-5500, UNI-9000

HSA1061 Uni-Tab Straight Pulling Tabs

- Steel use only
- Utilize tabs for pulling dents instead of steel studs
- 100 tabs included
- Works with UNI-1063 tab adapter, UNI-9600 tab shooter, UNI-9500



HSA2004 10PK M4 Pulling Tabs



HSA2006 10PK M6 Pulling Tabs

- Screw on aluminum studs for pulling dents



M4 Aluminum Pulling Studs (Al-Mg Studs)

- M4 Al-Mg studs for aluminum dent pulling applications
- Threaded for use with pulling tabs
- For use with UNI-9700, UNI-9800, UNI-9850

HSA1142 - 250 Pack



HSA1065 Uni-Rod Tab Pulling Rod Kit

- For use with UNI-1091, UNI-1092, UNI-1093 Bridges
- Rods included: 4", 10", 14", 18"

CLAMPS



KT158809

9" Welding Locking Clamp

- U-shaped jaws for improved visibility and less obstruction to work area
- Perfect for welding applications or securing awkward-shaped work pieces
- Manufactured from high-grade heat-treated alloy steel
- Adjusting screw tightens to adjust pressure for a secure, firm grip every time
- Lifetime warranty

WARNING: Cancer and Reproductive Harm - www.P65Warnings.ca.gov



MOC0655

Dyna-Mo Box™ Clamp

- These heat treated jaws reach around flanges and other obstructions to get a grip on hard-to-reach surfaces
- Severe duty tooth design for aggressive pulling power
- Heat treated steel

Specs:

- Gripping Surface: 1 1/4" wide (32 mm), 1/2" deep (10 mm)
- Overall Length: 8" (201 mm) • Capacity: 3 tons (2,722 kg)
- Weight: 4 lbs (1.81 kg)

MOC0054

Mini Spring™ Clamp

- Heat treated steel
- Spring loaded for easy opening
- Includes Oval Loop for use with Slip Hook for easy hook-up
- For gripping light sheet metal in those tight places
- Cross-hatch tooth design for an aggressive bite

Specs:

- Gripping surface: 1-1/2" (39 mm), 3/4" deep (19 mm)
- Overall length: 6" (152 mm) • Capacity: 3 tons (2,722 kg)
- Weight: 3 lbs (1.36 kg)



MOC0305

Dyna-Mo™ Junior Clamp

- Gripping Surface: 1-1/4" wide (32 mm), 1" deep (25 mm)
- Overall Length: 7" (178 mm) • Capacity: 3 tons (2,722 kg)
- Weight: 2 lbs (.91 kg) • Heat treated steel
- Lifetime warranty does not cover abuse



MOC0550

Tight Opening Clamp

- Gripping Surface: 1-1/2" wide (38mm), 1/2" deep (13mm)
- Overall length: 6-1/2" (165mm)
- Weight: 3 lbs (1.36 kg)
- Capacity: 3 tons (2,722 kg)
- Heat Treated Steel.
- Lifetime warranty does not cover abuse

MOC0250

Mini C™ Clamp

- Self-tightening
- Small, light, versatile
- Has a minimum of 1-1/2" throat clearance to reach around flanges, cowls, pinch welds and lips
- Butts against panels where only narrow bite is available
- Made of heat treated steel

Specs:

- Gripping surface: 1-1/2" wide; 3/4" deep
- Overall length: 8-1/2"
- Weight: 6 lbs.
- Capacity: 5 tons



MOC0440

Twin Claw™ Clamp

- Self-tightening, twin claw jaws and drop-forged wedge distribute the clamping load - reducing the possibility of metal tearing
- Severe duty tooth is designed for maximum gripping bite and minimized metal distortion
- The jaw openings allow use around lips of core supports and aprons, clamps to floor pans and other pulls
- Made of heat treated steel

Specs:

- Gripping surface: 4" wide (102 mm)
- Overall length: 8" (203 mm)
- Weight: 8 lbs (3.63 kg)
- Height: 3" (76 mm)
- Capacity: 5 tons (4,536 kg)



MOC0750

Lip Grip™ Clamp with Side Pull

- Multi-purpose clamp with gator teeth for sure, non-slip pulls on any lip
- Use the Lip Grip as a sandwich clamp on quarter panels or floor sections
- The chain loop permits pulling at any angle
- Side pull bracket adds a 90° angle for two directional pulling
- Overall length: 6-1/2"; weight: 7 lbs.; capacity: 4 tons
- Gripping surface: 2" wide, 5" deep
- Made of heat treated steel

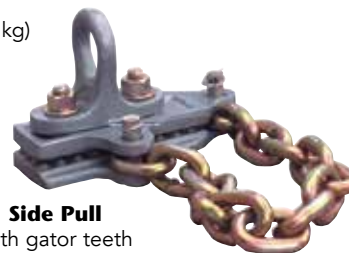

CLAMPS



MOC0660

Long Nose™ Clamp

- Similar to the popular # 0300 Jr. Clamp, the Long Nose is self-tightening and includes the original wedge
- Cross hatch tooth design, spring loaded for easy opening, deeper reach for hard-to-get-to areas
- Heat treated steel

Specs:

- Gripping surface: 1-3/4", 1" deep
- Overall length: 9-1/2"
- Weight: 6 lbs.
- Capacity: 5 tons



MOC0670

Baby Box™ Clamp

- Self-tightening
- Great for single-lip flanges and inside frame horns
- Original wedge; cross-hatch tooth design; spring loaded for easy opening
- Throat clearance of 1-1/2" high, 1-1/4" deep
- Gripping surface: 1-3/4" wide, 1" deep
- Overall length: 9-1/2"; weight: 7 lbs.; capacity: 5 tons
- Made of heat treated steel



MOC0100

B® Clamp

- Self-tightening
- The body-man's right arm
- It grabs 2-1/4" (57 mm) of metal, making it ideal for hard pulls on heavy metal or frame
- Original wedge and straight cut tooth design
- Heat treated steel

Specs:

- Gripping surface: 2-1/4" wide (57 mm), 1" deep (25 mm)
- Overall length: 9-1/2" (241 mm)
- Weight: 7 lbs (3.18 kg)
- Capacity: 6 tons (5,443 kg)



MOC0250

Mini C™ Clamp

- Self-tightening
- Small, light, versatile
- Has a minimum of 1-1/2" throat clearance to reach around flanges, cowls, pinch welds and lips
- Butts against panels where only narrow bite is available
- Made of heat treated steel

Specs:

- Gripping surface: 1-1/2" wide; 3/4" deep
- Overall length: 8-1/2"
- Weight: 6 lbs.
- Capacity: 5 tons



MOC4010

Frame Rack/Unibody Clamp

- The clamps have recessed pockets to hold the bolts stationary for easy tightening
- Heat treated steel
- Gripping surface: 8" wide
- Overall length: 14" (368mm); weight: 19 lbs.
- Capacity: 5 tons



MOC4020

Four Way Pull Clamp™

- Clamp has recessed pockets to hold bolts stationary for easy tightening
- Includes #4043 Oval Loop
- Made of heat treated steel

Specs:

- Gripping surface: 4" wide; 3/4" deep
- Overall length: 8"; weight: 12 lbs.
- Capacity: 6 tons



MOC4030

Three-Way Pull Clamp®

- Clamp has recessed pockets to hold bolts stationary for easy tightening
- Includes #4043 Oval Loop
- Made of heat treated steel
- Gripping surface: 4" wide, 1/2" deep
- Overall length: 8"; weight: 8 lbs.
- Capacity: 6 tons



MOC5800

G Clamp™

- Easier pulling with multiple pulling angles
- Has a throat opening of 4" allowing plenty of room to get over, around and behind the damage
- The movable shackle means more versatility
- Made of heat treated alloy steel for extra strength
- Includes swivel pad

Specs:

- Overall length: 10-1/2"
- Overall width: 6"
- Weight: 6 lbs.
- Capacity: 4 tons



CLAMPS



VIMSLP5

Adjustable Slide-Lock Pliers with "L" Jaw

- Easy and efficient one handed push button release
- Clamp sheet metal with a slide action keeps parts from moving during clamping
- Satin chrome with heat treated alloy jaws
- Perfect for fabricators and body shops
- Limited Lifetime warranty



Innovative autobody tools and equipment



STC35753

Work Stand Clamp

- Great for use with Steck #21890 Skin Zipper to hold car door in place on work stand (x-frame)
- Can also be used with other door skinning tools
- Holds parts for prepping jambs
- Simple and inexpensive plier to clamp a car door or other panel to a work stand quickly and securely



WIL410

10" Forged C-Clamp

- Industry's top choice for maintenance, production and repair operations
- Drop-forged steel frame, regular-duty with extra deep-throat
- Black oxide coated spindles and Perma-pad® resist corrosion, and are replaceable
- Innovative frame geometry for maximum strength
- V grooved anvil allows secure holding of all materials including rounds, squares and flats

WARNING: Cancer and Reproductive Harm - www.P65Warnings.ca.gov



WIL540A-10

C-Clamp with 0" to 10" Jaw Opening

- Frames made from high strength ductile iron castings
- Sliding pin (vise type) handle, single acme thread rolled spindle and oscillating ball and socket tip
- Wilton's heaviest-duty carriage clamp available
- Black oxide coating
- Lifetime warranty

WIL540A-8

C-Clamp with 0" to 6" Jaw Opening, 2-3/4" Throat Depth

WIL540A-6

C-Clamp with 0 to 8" Jaw Opening

WARNING: Cancer and Reproductive Harm - www.P65Warnings.ca.gov



WIL22008

12" C-Clamp

- Frames made from high strength ductile iron castings
- Sliding pin (vise type) handle, single acme thread rolled spindle and oscillating ball and socket tip
- Wilton's heaviest-duty carriage clamp available
- Lifetime Warranty

WARNING: Cancer and Reproductive Harm - www.P65Warnings.ca.gov



WIL4PC540CL

4 Piece Wilton 540A Series C-Clamp Kit with Duffle Bag

- Contains the 4 most popular 540A Series C-Clamps
- Sizes include 2-1/2", 5", 8" and 10"
- Includes Wilton logo duffle bag for easy carrying
- Ideal for light industrial, woodworking, and repair applications
- Frames made from high strength ductile iron castings. Sliding pin (vise type) handle. Single acme thread rolled spindle and oscillating ball and socket tip
- Lifetime warranty

WARNING: Cancer and Reproductive Harm - www.P65Warnings.ca.gov

CLAMPS



Adjustable C-Clamp

- Made of ductile iron

KTI70182 - 2" **KTI70184** - 4" **KTI70188** - 8"

KTI70183 - 3" **KTI70186** - 6"

WARNING: Cancer and Reproductive Harm - www.P65Warnings.ca.gov



BODY PULLERS



KILART38-220DX **Deluxe Dent Removal** **System 220 Volt**

- 5 times faster than using pin welders
- Comes with pulling package and welding cart
- 5 year limited warranty • Built in the USA
- Complete with 6 finger claw, wiggle wire and 20' cord

KILART38-110DX **Deluxe Dent Removal System 110 Volt**



LNXP2000 **230 Volt Portable Dent Puller**

- Primary voltage: 208/230 single phase 60/50 Hz
- Size: 11-1/2"H X 15"W x 16-3/4"L • Line fuse: 30 AMP
- Power input cable: 25', No. 12/3 wire
- Cable assembly length: 7' ground, 7' power
- Maximum welding capacity: 20 gauge Autobody steel
- Weight: 64 lbs. (29 kg)

The LENCO LP-2000 portable dent pulling system comes with its own specially designed transformer. The star tip on the unit welds directly to the panel, eliminating the need to constantly weld, cut, and grind with draw pins. The power lead assembly is lightweight, easy to use and allows for single tool operation, saving valuable time and labor. The LP-2000 also comes with the A-201 shrinking tip, which can shrink light gauge metals.

LNXP2000/120 **120 Volt Portable Dent Puller**

BODY PULLERS



DENDF-HD0140

Flexible Fender Puller with Pull Ring - 1.5 Ton

- Flexible - fits any wheel well or liped panel
- 1.5 ton rated - more than enough power and strength
- Easy to use - spring loaded hinges hold clamp in position
- All-in-one tool • 1 year warranty

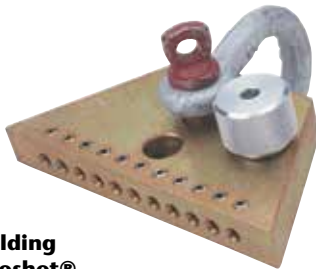

HSA1080

Uni-Clamp Multiple Welding

Stud Puller by H&S Autoshot®

- Uni-Clamp allows you to pull 2 to 11 studs with body frame equipment or even a come-along. Make pulls you never thought possible!
- Use narrow 5 hole side for tighter areas, use wide 11 hole side for larger pulls



COLLISION REPAIR TOOLS & ACCESSORIES



MOC0800

Tac-N-Pull Set with 3 Pull Plates

- Gripping surface: Up to 3" wide (76 mm)
- Overall Length: 5" (140 mm)
- Weight: 3 lbs (1.36 kg)
- Capacity: 3 tons (2,722 kg)
- Made of heat treated steel
- Lifetime warranty does not cover abuse



Innovative autobody tools and equipment

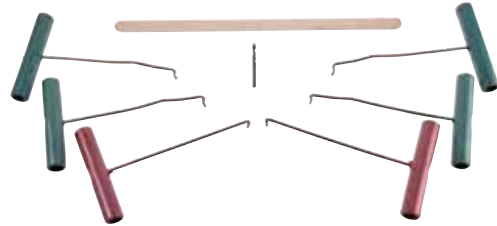

STC20000

"The Original" Pull Rod Set

- Super tough alloy steel is precisely heat-treated for maximum strength
- Every Steck Pull Rod and Pick Pull is factory tested under a 500 pound (228 kg) load.
- Vinyl coated handle is comfortable to use



Set includes: (4) Pull Rods, (2) Pick Pulls, (1) Stainless Steel Straight Edge, (1) HS Split Point Drill Bit, (1) Instruction Sheet



STC20022

Quarter Puller

- Pulls rear quarter and wheel well hooks above the lip of the wheel opening
- Two curvatures (one on each side) will fit almost all cars
- Easier and faster than clamps or jacks
- 3000 lb. maximum pull



STC20033

Quarter Puller QP2 (Small)

- Hooks above the lip of the wheel opening
- Two curvatures (one on each side) will fit almost all cars
- Easier and faster than clamps or jacks
- 3,000 lb. maximum pull
- For smaller openings



STC20085

EZ Pull™ Pliers

- Allows body shop technicians quick access to grip and pull multiple pull pins (studs) as well as vertical and horizontal flanges
- Tough alloy steel locking pliers with its 3-1/2" x 1" vice jaw provides an evenly distributed pulling force while pulling multiple pull pins and flanges
- Two large pulling rings to accommodate up to 2,000 lb. light pulling capabilities with standard pulling hooks
- Gives body shop technicians quick and easy clamping capabilities saving them set-up time over traditional heavy pull clamps and minimizes re-welding time to replace cut pull pins and/or flanges

BODY PULLERS



STC20222

Handy Pull Kit

- Allow a technician to perform light duty pulling of tapped holes in automotive body structures as well as proper hood and trunk alignment
- Contains three metric (6mm, 8mm and 10mm) eye bolts, 3-1/4" metal Offset Hinge Pull Plate and a 3" right angle metal Backing Plate with multiple patterned metric holes allows a body technician to easily perform light duty pulls for core support and body panels
- The Offset Hinge Pull Plate with a 3/4" hook hole and two bolt holes allows the technician to easily attach to damaged hood and trunk hinge holes to pull them into proper alignment



URE6146

Bumper Pliers Kit

- Accurately repair torn slots and recessed bolt hold in bumper covers
- Increase shop profits by speeding difficult repairs
- Reduce sanding time by squeezing plastic to correct thickness
- Restore correct dimensions of slot for proper panel installation
- 7 different sized forming dies fit most bumper slot sizes



LT1825D

Roller Rod Paintless Dent Removal Kit

- Second generation Paintless Dent Removal Kit
- New roller tip technology
- (5) 12mm diameter stainless custom rods -- 24 to 36" long
- Seven interchangeable tips
- Custom blow molded case

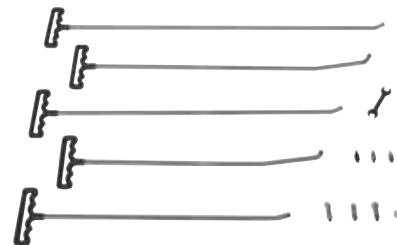

DENT PULLERS



DENDF-505/110 505/110 Maxi Dent Removal System, 110 Volt

- Provides power needed to shrink, pull rocker panels, hail damage, creases, dents
- Increases workers productivity while producing a cleaner, better repair
- Weld a slide hammer directly to the panel, a light pulling rod and even a wiggle wire for even crease pulling
- Weld a rod for leverage pulling
- Shrink metal
- 5 year warranty on material and workmanship



DENDF595-II "HammerHead" Dent Puller

- Replace your stud welder with our 100 volt version of the Maxi II
- Same great quality, same essential accessories that provides the technician with the means to higher productivity and better results • 1 year warranty

Pin/washer tip, Wiggle wire tip, 1 pound wiggle wire, shrink tip, 3 finger claw, slide hammer rod and weight, short pull rod, leverage puller and ground magnet included.

DENT PULLERS



KILART166 Pneumatic Dent Puller

- Provides maximum suction power
- 3 different pad sizes
- Quality steel construction
- Uses shop air line
- Complete with blow molded case

Nothing can compare to the power of using the shop air line to produce a venturi vacuum effect. This dent removal system is easy to use. It comes with 3 different pad sizes.



HSADK1000 Dent Killer - Dent Puller Attachment

- Works great to restore body lines
- Works with all UNI-SPOTTER stud welders
- Quick and easy to use
- Lightweight and portable for out-of-position pulls



HSA1016 T-Handle Slide Hammer

- Has been designed with a 4 jaw collet which firmly grips the stud and does not let go until you release it
- The "T" handle gives the operator a comfortable ergonomic grip
- The tapered head allows for tapping the panel close to the stud



HSA1095 Mini Stud Pull'r

- Designed with today's lightweight panels in mind
- The Posi-Cam locking system lets you quickly grip studs for hand pulling
- The narrow design gives full view of the pulling area

HOOKS

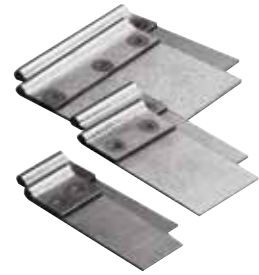

MOC0805 Tac-N-Pull™ Pull Plate Kit

- For use with the 0800 Tack-n-pull clamp (not included)
- Reusable plates
- Includes the following: (10) 0801 1" Pull Plates, (5) 0802 1" Pull Plates, and (5) 0803 3" Pull Plates
- Heat-treated steel



This is used for hard-to-hold pulls. It's simple to use, just tack weld one of the reusable plates, attach clamp and pull. When finished, break the tack weld with a grinding cut-off wheel or cutting torch.

MOC1250 Panel Puller™

- Light and easy to use with slide hammer or pulling post
- Use the Panel Puller on fender openings, deck lids, door posts and other openings
- Heat treated alloy steel
- Overall Length: 8" (203 mm)
- Width: 3" (82 mm)
- Weight: 3 lbs (1.36 kg)
- Capacity: 3 tons (2,722 kg)



MOC5616 Door Post Puller/Twister

- Designed to put a twist when you pull with its V-shaped gusset
- For the use on bolt-type hinge pillars
- Made of heat-treated steel
- Overall length: 5" (133mm)
- Weight: 2 lbs (.91kg)
- Capacity: 2 tons (1,814kg)



MOC6325 Hook Cluster

- Mo-Clamp introduces the "Tie down hook cluster" with all the most popular tie down hooks on one chain
- Find your "R", "J", "T" and 3/8"
- Grab hooks all together.
- Made from the same quality steel alloy as the individual hooks, the cluster will provide years of use with the convenience of having all your hooks in one place.
- No need to worry about these hooks, as they are covered by the Mo-Clamp "forever" warranty and made in the USA.



HOOKS



MOC5623 Hinge Plate™

- Use in existing holes in frame structures or body panels
- Comes with #5626 3/8" Shackle for angle pulls
- Made of heat treated steel
- Overall length: 4"; weight: 2 lbs.
- Capacity: 3 tons



MOC1300 Sill Hook™

- One of the handiest tools in the shop for a quick pull almost anywhere
- New round opening allows for pulling with a slip hook
- New casting process makes for a tighter grain structure, resulting in more strength
- The original straight-cut tooth design is machined for superior gripping and pulling power
- Heat treated steel



Specs:

- Gripping surface: 2-1/2" wide (63 mm), 1" deep (25 mm)
- Overall length: 8-1/2" (216 mm)
- Weight: 5 lbs (2.27 kg)
- Capacity: 5 tons (4,536 kg)

MOC1350 Versa Hook™

- A versatile tool used as an outer track tie-down to secure vehicles during pulls
- It is used as a pulling device for rocker panels, door posts, windshield posts, etc.
- Original straight-cut tooth design
- Versa Hook end is 2 1/2" wide



Specs:

- Gripping surface: 2 1/2" wide (63 mm), 1" deep (25 mm)
- Overall length: 8" (203 mm)
- Weight: 6 lbs. (2.72 kg)
- Capacity: 8 tons (7,257 kg)

MOC4120 Double Claw Hook

- Used as an accessory with draw bars or chain
- Use a pair with triangle or oval loop as a chain sorter, double hook, or bumper hook
- Designed for use with 3/8" chain
- Heat-treated steel

Specs:

- Overall Length: 5" (127 mm)
- Weight: 2 lbs (.91 kg)
- Capacity: 6 tons (5,443 kg)



MOC3100 Sheet Metal Hook™ Set of 4

- Alloy heat-treated hooks increase pulling options
- May be used with the #0810 and #0820 Hole Pull Plates to pull, or use in combination with clamps
- Weight: approximately 2 lbs. each; capacity: 2 tons
- Made of heat treated steel

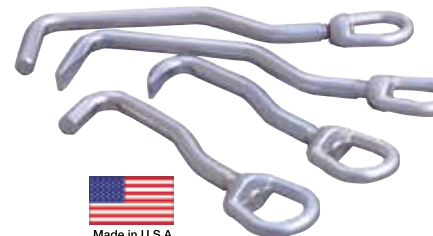

Set includes: #4051 Eye Nut, #3110 Small Flat Nose Hook, #3120 Small Round Nose Hook, #3130 Large Flat Nose Hook, #3140 Large Round Nose Hook

MOC3110 Small Flat Nose Sheet Metal Hook™

- Alloy heat treated hook increases pulling options
- May be used with #0810 and #0820 Hole Pull Plates to pull, or use in combination with clamps



MOC3120 Small Round Nose Sheet Metal Hook

- Alloy heat treated increase pulling options
- May be used with hole pull plates (0810 & 0820) to pull, or use in combination with clamps

Specs:

- Weight approx: 2 Lbs (.91 kg)
- Capacity 2 Tons (1,814 kg)



MOC3130 Large Flat Nose Sheet Metal Hook

- Alloy heat treated hooks increase pulling options
- May be used with #0810 and #0820 Hole Pull Plates to pull, or use in combination with clamps

Specs:

- Weight: approximately 2 lbs (.91 kg) each
- Capacity: 2 tons (1,814 kg)



MOC6400 Regular Deep Hook Set™

- For fast hook-ups on cowl, door posts and truck openings, or to reach into cramped places
- Heat treated steel

Specs:

- Overall Length: 19" (482mm)
- Throat Depth: 6" (152mm)
- Throat Opening: 14" (356mm)
- Weight: 19 lbs (8.62kg)
- Capacity: 5 tons (4,536kg)



HOOKS



MOC4145

Welded Double Clevis

- For quick shortening of a 3/8" chain
- Made of heat treated steel

Specs:

- Overall Length: 8" (222mm)
- Weight: 3 lbs. (1.36kg)
- Capacity: 10 Tons (9,072 kg)



Made in U.S.A.

MOC4146

Double Grab Hook Assembly

- Grab hook on one end; slip hook on the other
- For hooking into clamps or pull rings
- Fast hook up to any section of 3/8" chain
- Made of heat treated steel

Specs:

- Overall Length: 9" (241mm)
- Weight: 3lbs (1.36kg)
- Capacity: 7 tons (6,350 kg)



Made in U.S.A.

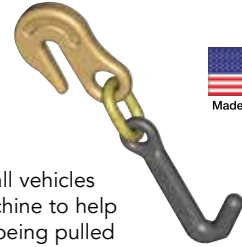

Made in U.S.A.

MOC6318

"J" Hook with Grab Hook

- Original shipping tie down for all vehicles
- Excellent around the frame machine to help hold a frame while diamond is being pulled

Specs:

- Overall Length: 6" (228mm)
- Weight: 2 lbs (.91kg)
- Capacity: 4 tons (3,629kg)



MOC6313

Ford "T" Hook with Grab Hook

- Original shipping tie down for Ford vehicles
- Excellent around the frame machine to help hold a frame while diamond is being pulled

Specs:

- Overall Length: 9" (228mm)
- Weight: 2 lbs (.91kg)
- Capacity: 4 tons (3,629kg)



Made in U.S.A.

FRAME MEASUREMENT



DENDF3D

Digital Measuring Tram

- Taking point-to-point measurements from 1 to 12 feet (300-3640 mm)
- The tram user can measure in feet, inches, 1/16's of an inch and metric measurements with the touch of a button
- The zeroing function enables you to take comparison measurements, displaying the appropriate positive or negative reading
- Placing the center pointer on the prescribed 400 mm mark, measurements shorter than the collapsed length of the tram can be made

Includes: 3 350mm long pointers; 2 110mm short pointers; 2 bullet pointers, 2 pointer holders, 2 cones for zeroing out larger holes all stored in a plastic carrying case.

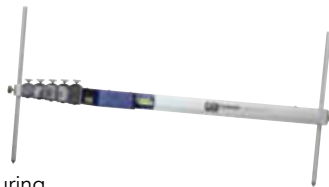

DENDF-3TC3

9' Short Measuring Tram

- Quick, easy one person measuring
- Accurate
- Internal Tape
- Telescopic
- Lightweight aluminum sectional body

No need to add up sections, the internal tape reads out through a display window. Extruded aluminum sections make this tram light weight yet rigid when fully extended. This tram extends to almost 10 feet, is accurate to +/- 2 mm.



DENDF3

Measuring Tram Gauge

- Manufactured in Switzerland, this extruded aluminum tram is lightweight yet remains rigid when fully extended
- The telescoping design allows for confident one-person operation
- Standard and metric measurements are read easily through a large display window
- Take point to point measurement from 3 to 10-1/2 feet (950-3250 mm)
- Only extend as much as you need; No sections to add up
- 1 year warranty on material and workmanship

FRAME MEASUREMENT



KILART90MINI Mini Squaring Tram

- Rigid telescopic tubing
- Extends 20" to 58"
- Easily fits under the hoods of small vehicles like Honda Fit
- Comes with 2.5" & 2.12" calibrated pointers and nylon bag
- Built in the U.S.A.



KILART90AS Tram Gauge Cone Adapter Set

- All cones are self-centering for accuracy
- 2 cones for holes up to 40mm
- 4 reverse cones for bolts and nuts up to 19mm
- Machined aluminum for durability
- Pointers fit all tram gauges
- 1 year warranty on material and workmanship



KILART90 Professional Telescoping Measuring Tram

- Telescoping aluminum tram with steel locking screws
- Measures from under 6" (approx. 150mm) to 15' (4572mm)
- See EZ to read metric/British measurements through viewing window
- MEASURING TRAM - Telescoping aluminum tram gauge with steel locking screws and viewing window.
- VERSATILE - Right angle pointer allows for short measurements under tram length.

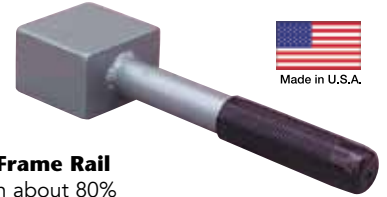

MOC5710 Mo-Block™ Dolly for Frame Rail

- Straighten frame rails in about 80% of front-end damage cases
- Inserted into the frame rail pocket, the dolly straightens the high strength, low-alloy metal easily and quickly
- This Dolly design keeps hands and fingers safely away from the impact area



MOC7050 2-1/2" to 7' Baby Tram Gauge with Case

- Measures from 2" (65mm) to 7 ft. (2.1m)
- Level bubble installed in sliding head for accuracy in measurement
- Includes hard plastic storage case

The Tram Instrument makes it easy to establish dimensions around components and to check contours by comparing measurements from one side of the vehicle to the other. This tram instrument is a versatile and indispensable tool for determining collision damage to uni-body cars and for checking critical measurements during repair.

MOC2450 Boltless Strut Tower Pulley

- Developed for strut towers without bolts, to correct chassis dimensions to factory specifications
- Overall Length: 5" (127 mm)
- Weight: 8 lbs (3.63 kg)
- Capacity: 3 tons (2,722 kg)



MOC5810 Down-Pull Assembly™

- Works with pulling towers and bench systems
- Large 5 inch wheel prevents undue chain wear
- When used with the #5811 Block Pulley Adapter it offers horizontal pulls
- Overall Length: 71/2" (190mm)
- Weight: 16 lbs (7.26kg)
- Capacity: 5 tons (4,536kg)



MOC4049 Frame Wrench

- Manufactured from heat treated steel
- Allows easy access to the bends and waves resulting from frame straightening
- Two different angles to access the difficult underside of vehicles



RIVETERS, KITS AND RIVETS



DENDF-CT887

Slimline Plastic Pop Riveter

- Slim profile - Riveter is one inch tall and requires only two inches clearance to fully pull a plastic rivet. Bumper fascia, fender walls and other inaccessible areas no longer need to be taken apart
- Greater accessibility
- One handed use
- Pulls 2 sizes of rivets
- 1 year warranty



DENDF-CT888

Swivel Slimline Plastic Riveter

- Rotational Head – easily get into hard to reach places
- Slimline Profile – less than 1.75" head and requires only 2.25" clearance for pull
- Interchangeable Tips – 5.0mm and 6.3mm tips add versatility
- Locking Clip – metal clip swings keeps the handles together when not in use for smaller footprint



DENDF-SPR69

SPR Push Pull Riveter

- Dynamic tool for riveting aluminum panels (up to 6.5mm) together with SPR or Flow Form Rivets
- PUSH/PULL System is an innovation that facilitates insertion and removal of rivets
- Ergonomic design allows for easy and comfortable use
- Pneumatic operation ensures continual pressure
- Extracting, Flow Form, Leveling and Punch/Shape matrices, shoulder strap, HR1S arm, a sample of self-piercing rivets, and a carrying case



DENDF-SPRFORD

SPR Die Set for Ford

- SPR Matrix Kit for Ford
- For use with the DF-SPR67 and DF-SPR69 SPR Riveters
- Matrices are stored in padded box

SPR Rivets

- Zinc coated steel rivets for aluminum panels
- Universal use



DENDF-SPR34 - 3.3 x 4.0mm, 200 Piece

DENDF-SPR55 - 5.3 x 5.0mm, 100 Piece

DENDF-SPR56 - 5.3 x 6.0mm, 100 Piece

DENDF-SPR57 - 5.3 x 7.0mm, 100 Piece

DENDF-SPR58 - 5.3 x 8.0mm, 100 Piece

DENDF-SPR58 - 5.3 x 9.0mm, 100 Piece



JLM1500

Magna-Spot 1500 Stud Kit

- Includes all the basic requirements for today's professional collision repair technician
- 5 year warranty
- Unique, solid quality, U.S. manufactured product
- Blow molded carry case included
- 9 foot heavy gauge oil resistant power cord; 120 VAC 1 PH 50/60 Hz 15 A
- 1 year warranty on material and workmanship

RIVETERS, KITS AND RIVETS

PA Astro



AST1427

Hand Rivet Nut Kit

- Kit works with rivet nuts in sizes M5, M6, M8, M10 and M12
- Hand screw design for loading and unloading the nuts
- Unique hidden spring design for the return of the handle
- Compact and lightweight • Ergonomic handle

⚠ WARNING: Cancer and Reproductive Harm - www.P65Warnings.ca.gov



AST1450

13" PlusNut and Extra-Long Rivet Nut Setter Kit

- For setting bulbed PlusNut's, longer than standard rivet nuts and even standard rivet nuts
- Includes 9 SAE and Metric sizes: 10-32, 10-24, 1/4-20, 5/16-18, 3/8-16, M5, M6, M8 & M10
- Features the market's most popular rivet nut setting tool (1442) adapted for PlusNut and long rivet nut use
- Extra long mandrels in 10-32, 10-24, 1/4-20, 5/16-18, 3/8-16, M5 x 0.8, M6 x 1, M8 x 1.25, M10 x 1.5
- Quick-change 13" rivet nut setter and storage case
- 1 year warranty on material and workmanship

⚠ WARNING: Cancer and Reproductive Harm - www.P65Warnings.ca.gov

PA Astro



AST1423

13" Heavy Duty Hand Riveter

- Patented structure increases power and reduces shake
- Shortest long arm riveter which can operate up to 1/4" stainless steel rivets
- Shorter handle with double compound hinges that maximize leverage
- Ergonomic grip for easy operation
- 3 piece jaws are made of Cr-Mo steel

A one-piece collet case eliminates the need to adjust the tool when changing rivet diameters. Includes 5 nose-pieces: 1/8", 5/32", 3/16", 1/5", and 1/4".

⚠ WARNING: Cancer and Reproductive Harm - www.P65Warnings.ca.gov



AST1426

1/4" Heavy Duty Hand Riveter with 3" Nose Piece

- Extra long handles provide excellent leverage
- Includes 5 nosepieces: 1/8", 5/32", 3/16", 7/32", 1/4"
- Tool length 20-3/4"
- Rivet body receptacle included

⚠ WARNING: Cancer and Reproductive Harm - www.P65Warnings.ca.gov

RIVETERS, KITS AND RIVETS



AST1442
13" Nut/Thread Hand Riveter Kit with Nosepiece Set

- Patented structure increases power and reduces shock
- Shorter handle with double compound hinges that maximize leverage
- Includes hand nut/thread setting riveter
- 6 Interchangeable mandrel/nosepiece sets in metric M5, M6, and M8 and in SAE 10-24, 1/4-20, and 5/16-18

ASTRN14
100 Piece 1/4-20 Steel Rivet Nuts

- Zinc plated knurled steel rivet nut
- Thread pitch: 1/4-20
- Outside diameter: 8.9mm, length: 15mm
- Drill hole size: 9mm / 3/8", sheet metal grip range: 26 - 13ga
- Head Dia: 12.4mm, head thickness: 1.4mm



AST1452
XL Nut/Thread Setting Hand Riveter Kit 1/2" Capacity

- Makes setting extra large rivet nuts like 1/2" and M12 a breeze
- Includes six interchangeable mandrel/nosepiece sets in Metric and SAE sizes: M8, M10, M12, 5/16", 3/8", and 1/2"
- Tool-less Quick-Change Head design allows for easy changing of mandrels and nose pieces by hand
- Disassembly of the tool is never required, the unique spring loaded inner hex sleeve automatically locks the rotation of hand installed mandrels
- Also includes 10pc rivet nuts of each included size
- 1 year warranty on material and workmanship

WARNING: Cancer and Reproductive Harm - www.P65Warnings.ca.gov



STC21960
SPR Insertion Tool

- SPR Insertion Tool is a high grade hardened steel frame with a 1/2" 20 Grade 8 hex bolt with magnetic end and center recess to hold the replacement SPR while inserting the SPR with a 1/2" or 19 mm socket on your 1/2" impact wrench
- The SPR Insertion Tool allows the technician to control these repair processes without waiting in line for the very expensive hydraulic tools to do this same process
- Insert the new SPR on the magnetic end of the hex bolt, hand tighten to the flange area keeping the body of the SPR Insert tool against the door flange
- 90 day warranty on material and workmanship



MAR39058
1/4" Heavy Duty Air/Hydraulic Riveter

- Spent mandrels are easily removed from the twist open style collection bottle
- A 1/4 inch nosepiece for external locking structural rivets is included
- Recommended air pressure is 70-95 PSI
- Air connectors are 1/4 inches NPT

RIVETERS, KITS AND RIVETS



FSIPT-4500H Cordless Riveter - Huck Style - Tool Only

- Powerful: 5000lbs installation force
- Light weight
- Rapid stroke
- 18 VDC Lithium ION battery system
- Installs fasteners thru 1/4" diameter



FSIPT-4500HTCK Cordless Riveter Kit, Truck Cab Kit, Huck Rivets

- Powerful, light weight, portable
- High performance 18v LI-ION system
- Faster than an air operated riveter
- Installs rivets and lockbolts up to 1/4" diameter
- Rapid stroke
- Includes 2 batteries, charger and carrying case

Magna-Grip Pulling Heads

- Works with the PT-4500H
- Pulling head
- Compact

FSIF99-3204 - 1/4"

- 1/4" magna-grip
- 1/4" maxlok



FSIF99-3201 - 3/16"

- 3/16" Magna-Grip
- 3/16" Maxlok



FSIF99-3003 - 3/16"

- 3/16" C6L pulling head
- 3/16" C98LT pulling head



FSI2025TCFK Truck Cab Fastener Kit, Blind Rivets and Lockbolts

- All the fasteners required to repair your truck



Fastener Kit with Magna-Lok & Huck Lockbolts. Contains 1/4" Magna-lok rivets, 3/16" MG Steel Paccar Style Lockbolts w/ collars, 1/4" MG Steel Lockbolts w/collars & 3 sizes of 3/16" C98LT Stainless Steel Front Gillg Lockbolts w/collars. Supplied in a rugged hard shell plastic kit.



HUCKA175A Air Power Riveter

- Sets 1/8" through 1/4" steel rivets with up to 3500 lbs. of pull capacity
- Tougher and more durable
- Includes blow molded carrying case

HUCKH150A Air Power Riveter

- Up to 3500 lbs. of power
- Sets aluminum, steel and stainless steel rivets through 1/4"
- Sets 3mm through 3/8-24 TSN(r) style threaded inserts in steel or aluminum
- Nut setter kit available, but not included



HUCPR75 Quick-Set Hand Riveter for Plastic Rivets

- Durable tool sets most plastic rivets in a single stroke without re-gripping
- Efficiently designed for one-handed operation, the PR-75 will set the rivets properly without breaking the stem prematurely
- Won't cause damage to painted or easily marred surfaces
- Approved for use by Ford and General Motors



HUC202929 3 Piece Replacement Jaws for HUCKH150A and HUCKA175A Riveter



RIVETERS, KITS AND RIVETS



MAR39000

Marson® HP-2® Professional Hand Riveter

- Features a square shoulder fulcrum pin of cold-formed heat-treated steel, which prevents pin rotation that can cause hole elongation and premature tool failure
- Other quality features include: precision die-cast, high-strength aluminum alloy body, drop forged carbon steel upper handle
- Thick cushion-molded vinyl grips for comfort
- Sets up to 3/16" steel rivets and comes with four mounted nosepieces (3/32", 1/8", 5/32" and 3/16")



MAR39001

Marson® HP-2® Hand Rivet Kit

- Includes the HP-2 riveter and 200 assorted Klik-Fast rivets in the most popular sizes
- Great for almost any small to medium rivet job



MAR39010

Marson® Big Daddy® Riveter with Special Nosepieces

- Most versatile and powerful hand riveter
- It takes the hard work out of setting large diameter, blind rivets
- Extra-long handles provide excellent leverage and permit working a foot beyond natural reach
- Other features include a patented bearing design, self-adjusting, two-piece jaws and single-unit body construction
- Double-gear reduction system easily sets from 1/2" to 1/4" diameter Klik-Fast Rivets in all alloys, including 1/4" steel Klik-Split Rivets
- Supplied with 3/16", 1/4" and special 1/4" Klik-Split Rivet nosepieces



MAR39035

Marson® Big Daddy® Riveter with Extended Nosepiece

- Features 2" extended nose for reaching into hard to reach grilles and new car window applications
- Set 1/8" - 1/4" diameter rivets
- Includes 3/16" and 1/4" nose pieces
- Extra long handles provide excellent leverage

MAR39009

Marson® Big Daddy® Extended Nosepiece Adapter Kit

- Great for deep grills and new car window applications



Part Number	Type	Diameter	Grip Range	OEM Part#/Application	Per Pack
MAR48149	Klik-Lock Plastic Rivet	6.3mm	.158" - .236"	#GM14070914	20
MAR48150	Klik-Lock Plastic Rivet	6.3mm	.158" - .394"	GM14063981, CHRY6500911, AMC8934-201-531, or FORD N803043S	20
MAR42371	Klik-Split® Window Rivets	.250"	.032-.140"	FORD385189, CHRY 6031115	50
MAR42376	Klik-Split® Window Rivets	.250"	.520-.620"	FORD 385323, CHRY 6031091	50
MAR47411	Klik® Steel Poly-Nuts	.375"	.030 to .165"	Can be used in a wide range of applications	40
MAR47455	Klik® Steel Poly-Nuts	.375"	.020 to .165"	Can be used in a wide range of applications	40

RIVETERS, KITS AND RIVETS



**KT179100
Heavy Duty Hand Riveter**

- With 4 nosepieces to secure rivets
- Includes nosepieces: 3/32" (2.4 mm), 1/8" (3.2 mm), 5/32" (4.0 mm) and 3/16" (4.8 mm)
- Includes rivet samples

⚠ WARNING: Cancer and Reproductive Harm - www.P65Warnings.ca.gov



**KT179110
Riveter Super Duty Hand 17" Lo**

- Includes 5 Nosepieces, 1/8", 5/32", 3/16", 7/32" and 1/4"
- 17" Long Handles provide the leverage needed to effortlessly secure rivets

⚠ WARNING: Cancer and Reproductive Harm - www.P65Warnings.ca.gov



**SGT19200
Heavy Duty Hand Riveter Kit with 40 Rivets**

- Use this heavy-duty hand riveter to set 3/32", 1/8", 5/32" and 3/16" rivets quickly and easily
- Sets up to 3/16" steel or aluminum rivets
- Comes with 4 nosepieces, which are mounted on the heavy duty riveter
- Nosepieces are interchangeable by using wrench provided with tool

⚠ WARNING: Cancer and Reproductive Harm - www.P65Warnings.ca.gov



**SGT19400
Rivet Tool for Plastic Rivets**

- Sets most plastic rivets in one stroke without re-gripping
- Won't damage painted, plated or easily marred surfaces
- Long reach design accesses areas not accessible with lever type tools
- Sets all sizes using a single nosepiece
- Lightweight tool is designed for one hand operation
- All metal construction
- Not for use with metal rivets

⚠ WARNING: Cancer and Reproductive Harm - www.P65Warnings.ca.gov



**SGT19800
1/4" Super Duty Riveter**

- Easily sets five sizes of aluminum and steel rivets: 1/8" (3.2mm), 5/32" (4.0mm), 3/16" (4.8mm), 7/32" (6.0mm) and 1/4" (6.4mm)
- Long handles for greater leverage
- Comfortable handle grips
- Metal construction and simple design with few moving parts to ensure years of service
- 2-1/4" nose reach for standard use

⚠ WARNING: Cancer and Reproductive Harm - www.P65Warnings.ca.gov



**SGT19830
1/4" Super Duty Riveter with Extended Nose**

- Easily sets five sizes of aluminum and steel rivets: 1/8" (3.2mm), 5/32" (4.0mm), 3/16" (4.8mm), 7/32" (6.0mm) and 1/4" (6.4mm)
- Versatile and easy to use
- Long handles for greater leverage
- Comfortable handle grips
- Metal construction and simple design with few moving parts to ensure years of service
- 5-3/4" nose reach to access deep recesses such as grills, bumpers and window regulators

⚠ WARNING: Cancer and Reproductive Harm - www.P65Warnings.ca.gov



**TIT15052
10" Rivet Gun with Rivets**

- Includes 60 rivets
- Anti slip cushion grip handle
- Great for use in hard to reach places
- (4) Interchangeable nosepieces

Sizes include: 3/32", 1/8", 5/32" and 3/16".

BODY PANEL



DENDF-624CP

Clip Pliers

- Remove plastic clips safely
- Curved tip with grip teeth
- Quality steel construction
- Length: 7.25"
- Notched handle for extra grip



KDT84060

4-Piece Door Panel Kit

- Laser etched part number and size
- Tri-Lobe ergonomic handle to obtain optimal balance
- Innovative duel material handle for comfort and performance
- Oil and Solvent Resistant Handles • Black oxide tips for strength
- Lifetime warranty does not cover abuse

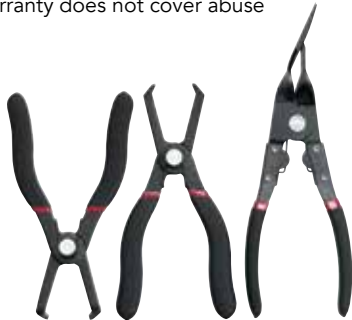

KDT41850

3 Piece Body Clip Pliers Set

- Includes 80 degree and 30 degree Push Pin Pliers
- Includes panel clip pliers
- Specially designed for removal of push pins with center locking pin
- Quickly removes plastic anchors that have center pins without damage to pins or anchor
- Panel clip pliers have a "V" design for removal of standard clips without center pins



KT170037

Clip Lifter

- Clip lifter for plastic fasteners, upholstery, door panels, plastic clips
- Tool length: 7" • Red rubber handle
- Tool width: 3/4" • Covered by a 1-Year Warranty

WARNING: Cancer and Reproductive Harm - www.P65Warnings.ca.gov

KT170038

Combi Wedge

- Color: Red
- Heavy duty universal combination wedge tool
- Use on dashboards and door cover clips
- Tool length: 8.5", width: 1", height: 1"
- Covered by a 1 year warranty

WARNING: Cancer and Reproductive Harm - www.P65Warnings.ca.gov



Innovative autobody tools and equipment



STC20014

Stud Lever™

- Grips studs (pull pins) quickly and easily
- Standard tool works on both 2.2 and 2.6 mm studs as close as 3/8" apart
- Black pivoting base helps compress crown as dent is pulled
- Includes STECK straight edge #20003 for matching original contours



STC23230

Plugweld Pliers

- Copper alloy backing plate prevents burn through (weld will not stick to the copper alloy)
- Plug weld pliers allow you to turn up your heat for better penetration without burn through, even if you have a pilot hole through the back panel

STC20099

Pogo II

- Fast leverage pulling and one handed operation
- Core supports repaired quickly
- Hook bolt heads, flanges, anywhere
- Fits in your toolbox (over all length 18-3/8")



BODY PANEL



Innovative autobody tools and equipment



STC20015SB

Seam Buster Spot Weld Chisel

- Chisel tip for starting seam separation
- Chisel edge for easily moving along seam
- Easily separate spot welded or bonded panels
- For quarter panels, rockers and any other pinchweld



STC20017

Super SeamBuster

- The Super SeamBuster can now be driven by means of an air hammer to separate spot welded or bonded panels
- The Super SeamBuster is designed to attach to any air hammer for faster and more efficient separating of quarter panels, rockers, bonded door skins and any other pinchwelds
- Sharpened on two edges which allows top sharp end for penetration between the panels and the lower edge allows for side impact to drive the panels apart
- The Super SeamBuster with its ability to attach an air hammer reduces technician arm fatigue and speeds the operation over traditional hammer and chisel removal techniques
- It is made from a super tough alloy steel and has a cushioned handle that absorbs the shock



STC20016

Right Angle SeamBuster

- Easily separates hard-to-reach spot welded or bonded panels
- Sharpened on three edges, the sharp end allows for penetration between the panels and both side edges allow for side impact to drive the panels apart without damage
- 90 degrees end for use in hard-to-reach pinchweld areas
- Made from a super tough alloy steel and has a cushioned handle that absorbs the shock



STC20046

3 Piece Panel Shaper Kit

- Air Hammer driven set of three self lubricating Nylon reinforced heads that allow the technician to easily access deep reach areas and badly deformed sheet metal surfaces to form them back to original shapes
- Each kit contains three unique Nylon head shapes with arbors that allow each tool to be attached to your air hammer to fix body lines, concaved areas and flat surfaces



Includes: chisel head which works with door, body lines, corner shaping and fender edges; rounded head which straightens out wheel house and quarter panels; flat head which straightens out floors, trunk floors and provide stress relief in the repair process.



TIT51507

Door Upholstery Remover

- 5/16" square tip design for removal of plastic fasteners from door panels
- Removes door panel fasteners
- Unique, square cutout in the tool tip provides a no-slip grip, even on fasteners with small ears
- Ergonomic soft grip handle for maximum comfort
- Lifetime warranty - does not cover abuse



TIT11566

6 Piece Mini Panel Removal Set

- Specially designed slim profile
- Shaped for many different applications such as removing dashboards, air vents, door panels, door locks, electronic seat controls, seat levers, center consoles, gear shifter and more
- High quality nylon material prevents scratches to painted surfaces and delicate panel surfaces
- Lifetime warranty - does not cover abuse



TIT15048

6 Piece Multi Wedge Trim Panel Tool

- Specially designed slim profile
- Shaped for many different applications
- High quality nylon material prevents scratching to painted surfaces and delicate panel surfaces
- Lifetime warranty - does not cover abuse



MAY13077

4-Piece Grippig Trim Tool

- Used for installing and removing automotive equipment, door and window trim, moldings, panels, and clips
- Black oxide finish
- Made of larger shank steel for heavy-duty applications



WARNING: Cancer and Reproductive Harm - www.P65Warnings.ca.gov



AST4505

Astro Clip, Fastener and Molding Remover 5-Piece Set

- For use on internal and external vehicle molding and trim fasteners
- Plastic construction of tools prevents scratching and damage to vehicle paint, leather, chrome, etc.



WARNING: Cancer and Reproductive Harm - www.P65Warnings.ca.gov

PLASTIC & FIBERGLASS REPAIR



DENDF-EZN1

Nitro EZ Plastic Welder - 1 nitrogen and 1 airless

- The DF-EZN1 EZ NITRO PLASTIC WELDER is unique in its use of proprietary Flow Adjust Switch Technology (FAST)
- The FAST system makes the DF-EZN1 the easiest nitrogen welder to learn and use. It simplifies nitrogen welding and eliminates flow adjustments by the user.
- Equipped with two welders, the DF-EZN1 EZ NITRO incorporates both a nitrogen welding torch and an airless welding torch.
- The nitrogen torch is air cooled. It is essential to establish and maintain air flow before turning the welder on, and air flow must be maintained until the nitrogen torch cools down.



DENDF-EZ10

Parking Sensor and Lens Hole Maker

- The Parking Sensor and Lens Hole Maker is the precise and clean way to create holes in order to install driver assist sensors on replacement bumpers.
- Easy to use with a wide variety of sizes make this tool a must have for any shop.
- Hole sizes: 17mm, 18mm, 18.2mm, 19mm, 20mm, 22.5mm, 24mm, 26mm, 26.7mm, & 32mm
- Cuts clean through the bumper



DENDF-EZN1G

EZ Nitrogen Plastic Welder Generator

- Eliminates the need for refilling nitrogen tanks and has a smaller footprint
- The proprietary Flow Adjust Switch Technology (FAST) system makes the DF-EZN1G the easiest nitrogen welder to learn and use
- Incorporates both a nitrogen welding torch and an airless welding torch
- Includes plastic rod in various types and sizes
- 110volts and a maximum of 10amps, total consumption is a maximum of 600 watts



DENDF-800BR

Hot Stapler Plastic Repair Assistant

- Staples plastic pieces together
- Allows flexibility for fitting the part
- Creates great strength to prevent re-breaking or cracking
- Save bumpers, headlight assemblies and other plastic parts
- 5 year warranty



DENDF-800ZC-50
DENDF-800MC/50

StapleClip - Z, Pack of 50
StapleClip - M, Pack of 50

PLASTIC & FIBERGLASS REPAIR



DENDF-400BR Hot Stapler - Basic Plastic Repair Tool

- Save bumpers, headlight assemblies or any other thermoplastic part by stitching them together with the DF-400BR Hot Stapler Tool
- This tool adds a structural element to cosmetic repairs
- The staples put the original strength back into the part, so now you save parts that would have been thrown away before
- No more cracking or breaking a part you spent time repairing, last minute fixes are no longer a headache
- The easy-to-use tool provides flexibility with 3 heat settings



DENDF-PUNT03 25 Pack 3mm Poly Plastic Rods

- Plastic: Polyurethane
- Size: 3mm
- Shape: Round
- Consumable plastic repair rods for the DF-EZN1 (sold separately) and other popular plastic inert gas welders.

25 Pack Poly Plastic Rods

- DENDF-PCNT03T** - 3mm Triangle
- DENDF-PCNT06** - 6mm Round
- DENDF-PCNT09** - 9mm Round
- DENDF-PCNT15** - 15mm Round



Made in U.S.A.



25 Pack ABS Plastic Rods DENDF-ABBK09 - 9mm Round



Made in U.S.A.

25 Pack Poly Plastic Rods DENDF-PEBK09 - 9mm Round DENDF-PEBK15 - 15mm Round



Made in U.S.A.

25 Pack Poly Plastic Rods DENDF-PPBK03T - 3mm Triangle DENDF-PPBK15 - 15mm Round



Made in U.S.A.



KILART251 Bumper Hole Punch for parking sensors

- No more drilling and sanding parking sensor holes
- Perfectly punched holes for that OEM look
- Punch holes through painted bumpers with perfect results
- 10 sizes for US and imported vehicles
- 1 year warranty on material and workmanship



AP Astro



AST7600 Hot Staple Gun

- Hot Staple Gun designed for quick repair and reinforcing broken/ripped/damaged/split plastic on autos, motorcycles, ATVs, boats, etc.
- Produces a strong durable repair while still leaving plastic flexible enough for correct fit
- Unique Staple Gun heats special designed staples and sets staples into plastic

Kit includes: Hot Staple Gun, Wire Cutter, Flip Screwdriver, 50 piece each of "M", "S", "V" and "Z" Style Staples. CSA Approved. Patent Pending.

WARNING: Cancer and Reproductive Harm - www.P65Warnings.ca.gov

AST7600M 50 Piece "M" Style Staple Pack for AST7600

WARNING: Cancer and Reproductive Harm - www.P65Warnings.ca.gov



PLASTIC & FIBERGLASS REPAIR

Polyvance
ADVANCING POLYMER REPAIR



URE6085-C

Nitro Fuzer Nitrogen Plastic Welding System

- Easy-to-operate, digitally-encoded temperature controls
- Flow gauge for repeatable performance every time
- Precision flow regulators on both the air and nitrogen sides
- Melt-proof silicone & fiberglass braided hot air welder hose
- Integrated airless welder control to allow for repair of thermoset PUR

URE6049-C

Nitro Fuzer Lite Welding System

- Fully capable nitrogen plastic welder for the budget-minded shop
- Automatic low-flow safety switch
- Precision flow control
- Flow gauge for repeatability
- Heavy-duty welding cart (assembly required)



Polyvance
ADVANCING POLYMER REPAIR



URE5700HT

Mini-Weld Model 7 Airless Plastic Welder Kit

- The Mini-Weld Model 7 Airless Plastic Welder is a complete kit that you can use to repair all kinds of plastic
- It's a complete, ready-to-use kit that is jam packed with benefits
- Things like an easy-to-understand instructional video lets you learn how to weld in no time
- Includes has two different, easy-to-swap welder tips for applying all of the included welding rod
- A temperature control that allows you to dial in the perfect temperature for welding whatever type of plastic you are working on



URE6203

Hot Spot Cordless Stapler

- Multi-position staple contacts
- LED light for illuminating tight spaces
- DC rechargeable power allows up to 700 staples on a single charge
- Simple one button operation
- Accommodates most staple sizes



URE5003R10

30' FiberFlex Flat Sticks

- Formulated with carbon and glass fibers for the strongest, fastest repairs; in many cases eliminating the need for wire mesh re-enforcement
- Sticks to any kind of plastic, but works especially well on TPO's
- Cool it off and sand immediately to a fine feather edge
- For use with Urethane Supply Company's Airless Plastic Welder
- Each stick is 1' long, approximately 1/8" thick by approximately 1/2" wide

PLASTIC & FIBERGLASS REPAIR



EZRH001
Cordless and Rechargeable Hot Stapler Plastic Repair Kit

- Adjustable angle
- 3 Heat settings for different plastics
- 3 (100 ea.) different staple types included
- Great for repairing broken locator pins, door panel clips, and tabs

Finished repair is strong and flexible. Expensive plastic parts can be saved. LED charging and low battery indicator lights. 110 V charger included.

EZRPU6
100 Pack of U Shaped Staples .6mm)

- Heating repair pin
- Comes in a clear locking case

• Stainless Steel



EZRPU8
100 pack of Staples (.8mm)

- Heating repair pin
- Comes in a clear locking case

• Stainless Steel



HSA8000
Hot Staple Plastic Repair Kit

- Compact gun provides 300 watts to quickly set staples & re-flow materials
- Includes interchangeable melt blades (curved and straight)
- 4 common types of scored-leg staples included
- Low profile storage case
- 1 year warranty on material and workmanship



KILART77P
Compact Hot Stapler

- Compact design with 2 power settings for production
- 3 staple settings for hard to get to areas
- Dual headlights for more light on subject
- Comes with 300 staples and a 5 Year warranty



KILART77XP
High Production Bench Top Hot Stapler

- Steel construction design for long life
- 3 heat settings for maximum production power
- 2 headlights in compact power wand
- 7 foot SJO cord
- Comes with 600 stainless steel staple variety
- Built with 18 gauge steel construction for long life



KILART77PC
Compact Hot Stapler

- Compact design fits into tight places
- 3 staple settings
- Machined brass electrodes for durability
- Bright LED'S for easy viewing

WARNING: Cancer and Reproductive Harm - www.P65Warnings.ca.gov

KILART77-W8
0.8mm Heavy Duty Wave Staples (Bag of 100)

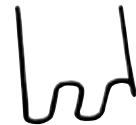

KILART77-F6
0.6mm High Production Stitching Staples (Bag of 100)



KILART77-F8
0.8mm Heavy Duty Stitching Staples (Bag of 100)

PLASTIC & FIBERGLASS REPAIR

EVERCOAT®
(Fiberglass
Evercoat)



**FIB370
Fiberglass Repair
Kit - Quart**

- Best for repair of fiberglass and metal surfaces
- Will rebuild rotted out areas on fenders, body sections and rocker panels
- Also used for forming special customized shapes
- Includes: 1 Qt. polyester resin, 11 cc liquid hardener, 6 sq. ft. fiberglass mat, fiberglass tape and instructions

**FIB498
Fiberglass Resin Gallon**

- Heavy thixotropic formula that will not run or sag and will cure to a non-tacky surface
- Wets out mat and cloth quickly
- Can be filed, sanded or drilled
- Impact resistant
- Waterproof
- Liquid hardener included

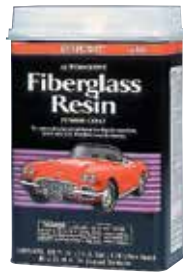

3M



**MMM4903
3M™ Duramix™
Plastic Contour Sheet, 5" x 12' Roll**

- Special film to be overlaid on Duramix just after it has been applied
- Prevents air entrapment when Duramix is condensed and contoured into the repair area
- Also allows for non-messy spreading of Duramix



**MMM4904
3M™ Duramix™
Reinforcement Patch, 5" x 12' Roll**

- Laminate of structural gauze and plastic release film
- Used for reinforcing the backside of plastic repairs
- Release film protects your hand from contact with wet Duramix®



3M



**MMM5888
3M™ Automix™
EZ Fix Flexible Patch, 4" x 8"**



- A flexible T.P.O. patch that is used to provide a strong backside reinforcement repair for most plastics
- Adhesive material: acrylic foam • 6 patches per box

**MMM6396
3M™ Automotive Adhesion
Promoter-Sponge Applicator Packet**

- 3M™ Adhesion Promoter is a liquid primer used for enhancing adhesion of 3M™ Acrylic Foam Tapes for interior and exterior trim applications
- Case Quantity 4 box per case Inner Pack 25 packets per box



**MMM5907
3M™ Automix™
Polyolefin Adhesion Promoter, 12 oz.**

- Adhesion promoter to be used with 3M™ Automix™ EZ Sand Flexible Parts Repair material, part numbers 05895, 05896, and 05887 for the repair of polypropylene and ethylene propylene interior and exterior parts



When making a System II repair, you must apply adhesion promoter after every sanding or grinding step until the plastic part is completely covered with primer.

**MMM5887
3M™ Automix™ EZ Sand
Flexible Parts Repair, 200ml**



- Two part epoxy used to repair most flexible plastic parts, including bumper covers and other plastic body panels
- Offers a 10 minute worktime; can be sanded with grade 180 abrasives in 30 minutes resulting in an excellent featheredge



SEM

**SEM39767
Problem Plastic Repair
Material 7 oz. Cartridge**

- Bonds to polypropylene, EPDM, TPO and similar substrates
- Takes the "problem" out of plastic repair



BODY SHEET METAL



Made in U.S.A.

DENDF-900DX

Aluspot Deluxe Aluminum Repair Station

- Everything you need to repair aluminum panels
- The most complete aluminum repair station from a name you know and trust
- The capacitor discharge welder is 110 volt powered. Re-charge time for the capacitors is less than 3 seconds. The ground is on the weld gun itself
- The fact that we have two ground points on either side of the weld gun also leads to a more successful weld rate

Everything you need is included:

Hammers, nylon & polished steel dollies, infrared temp gauge, digital heat gun, instructional CD and storage cart and 110 volt Alu-Spot welder. The DF-900DX includes everything found in the DF-900A but also includes a bridge puller, 3rd drawer and dust cover.



DENDF-900B

Aluspot Mini - Aluminum Repair System

- The DF-900B Mini Aluspot Repair System from Dent Fix Equipment is designed to operate as the main unit or as satellite unit
- The Aluspot Mini utilizes some of the same Dent Fix innovations and premier equipment as the larger Aluspot systems but at a fraction of the price
- Now, any shop can invest in the future and start repairing minor to moderately damaged aluminum panels
- Although the kit includes all the basics a shop will need to start repairing aluminum, shops can purchase additional pieces separately to expand their aluminum repair capabilities



BODY SHEET METAL



DENDF15DX Spot Annihilator Spot Weld Drill Kit

- Applies cutting pressure for you, no need to push
- Depth adjustable, cut out only the spot weld
- 1,000 rpm, for harder steels in todays cars

The drill applies all the needed cutting pressure to remove spot weld quickly and easily. The C-clamp is removable to access spot welds in floor panels and other hard to reach areas. The large depth adjustment ring controls how far the drill is allowed into the panel. This ensures that only the top panel is drilled, leaving the underlying panel clean and ready. The drill spins at 1000 rpm ideal for longevity of the bits and for the new Boron Steel (UHSS) panels.

Spot Weld Drill Bits

Part Number	Description
DENDF1690	Boron Killer® Drill Bit - 8x45mm
DENDF1480	High Speed Cobalt Drill Bit - 8x45mm
DENDF1680T	Titanium Nitride Drill Bit - 8x45mm
DENDF1680TC	Titanium Carbon Nitride Drill Bit - 8x45mm
DENDF1780	High Speed Cobalt Drill Bit - 8x80mm
DENDF1780T	Titanium Nitride Drill Bit - 8x80mm



DENDF-620TPS 12 Piece Trim Panel Scraper Pouch Set

- Easily and safely remove trim pieces instead of breaking them and having to replace them
- Most tool in this set are double sided increasing the overall utility of the set
- A heavy duty clip remover is made of metal for jobs where leverage can be used
- Includes a velcro canvas bag for storage and organization



DENDF-505 The 'Original Maxi' Dent Pulling Station

- Very powerful - 220 volt power
- Provides the technician with the power they need to shrink, pull rocker panels, hail damage, creases in hard to access areas and all types of metal damage
- The efficiency of this tool increases the workers productivity while producing a cleaner, better repair
- Five year warranty

Kit includes: The Maxi 220 volt unit, two light pulling rods, two slide hammer rods with strike weight, stud pin electrode, shrinking electrode, wiggle wire weld tip, a nine and four finger Bear Claw, 500 stud weld pins, 1 pound of wiggle wire, 21 feet of power cable, and nine feet of welding cable.

'Original Maxi' Dent Pulling Station Accessories

Part Number	Description
DENDF-507	Wiggle Wire - Thin 1lb
DENDF-507TK	Wiggle Wire - Thick 1lb
DENDF-503KM	Short Welding Rods - 5.5"
DENDF-503KF	Weld Keys - Flat
DENDF-503KT	Weld Keys - Twisted

DENDF-505DM Maxi Massager

- Add-on for the DF-505 Maxi
- Adjustable depth
- Fine finish work
- Weld rod slides in easily
- Massage steel pulls



BODY SHEET METAL



DENDF-900TP T-Hand Puller for ALU-SPOT

- Hand T-puller
- T-puller for DF-900DX
- Controlled pulls by hand
- Part of DF-900DX



DENDF-EZ1-AT150 150FT Aluminum Tape

- Used for backing when welding broken plastic parts together
- 150 foot roll



DENDF-BC200 4 Piece Level Adjust Butt Welding Clamps

- Easy to use welding clamps that anchor panels nearly edge-to-edge when mig brazing an open butt joint
- The gap adjustment allows the user to set distance for proper capillary attraction, which allows the bead to reflow through the gap and on the opposite side of the panel for the proper weld
- The level adjust feature allows accurate joining of two different panel thicknesses as well

DENDF-BL10A Body Line Tool

- Re-create fender curve lines perfectly every time with this tool - makes accurate measurements around wheel opening moldings quickly and easily
- Accurate re-creation of body line
- Made of solid anodized aluminum
- Adjustable for any fender line



STC21890 Skin Zipper™ Door Skinning Tool

- New Air Hammer driven door skinning tool that skins doors in less than 10 minutes using Skin Zipper's self lubricating reinforced Nylon head that will crimp regular or adhesive bonded skins
- The Skin Zipper crimps the edge tightly for a professional finish with no damage to the skin in an easy two step process
- Skin Zipper reduces technician arm fatigue from hammer and dolly method as well as door refinishing time
- The Skin Zipper head will skin approximately 10 door skins and is easy to replace when it wears out
- Saves the technician arm fatigue and up to 60 minutes of labor and assembly time by easily skinning the door with minimal refinish required to paint and/or reapply e-coating



KILART12DX Deluxe Door Skin Tool Kit

- Door skins applied in less than 10 minutes
- Deluxe kit includes extra chisel, extra spring and a blow molded case
- 5 year warranty
- Polished Stainless Steel Tool includes Air Hammer



BODY SHEET METAL

PA Astro



ASTDS1000

Pneumatic Door Skinner Tool

- Saves significant time and cost in skinning doors
- Forged and hardened steel crimping head is specially designed to roll the steel flanges over with a minimum of physical effort and leaves the flange smooth without unsightly ripples
- Produces factory like results in one pass
- Design allows tool to maneuver around inner and outer curves as well as most body design features. Close tolerance design and manufacturing, results in a tool that is incredibly smooth, quiet, and easy to use

WARNING: Cancer and Reproductive Harm - www.P65Warnings.ca.gov



AST17263

Solid Carbide Spot Welding Bit - 3 Flutes - 10mm

- 10mm drill bit especially designed for spot weld drilling
- Removes spot welds in Boron and other materials
- Made of ultra-hard Solid Tungsten Carbide which prevents bit dulling from overheating
- 3 flute design provides extra cutting surface which make cutting faster

WARNING: Cancer and Reproductive Harm - www.P65Warnings.ca.gov



ASTDS2000

Pneumatic Door Skin Remover Tool

- Forged and hardened steel de-crimping head
- De-Crimping head can be repositioned at various angles
- Secondary handle can be installed in either vertical or horizontal position
- Designed to unfold the steel flanges of a damaged door skin with a minimum of physical effort

WARNING: Cancer and Reproductive Harm - www.P65Warnings.ca.gov



HSA7600

Stud Buddy Stud Pulling Tool

- Allows for sensitive control of stud pulling, reduces overpulling
- Reduces panel repair time, increasing profitability
- Quick and easy multi pulls across a large repair area
- Quality material, functional design and simple construction



HSA7600-01

Lever Puller for Dent Repair

- An easy and effective way to pull dents
- Grip tabs on aluminum or steel
- Grips the lowest tab first and make the pull evenly, allowing the tool to do all the work
- The user no longer needs aggressive hand pullers that rely on brute force, the 7600-01 is the easy solution



VIMMPT

Magnetic Plug Weld Tool

- Designed to aid and speed up the welding of holes in steel body panels. It has a copper alloy pad that is placed behind the hole to be filled and a strong magnetic base to keep it where it is placed
- Electric weld will not stick to the copper pads
- Keeps wires from going through hole
- Copper pad dissipates heat



Innovative autobody tools and equipment



STC21730

Easy Pry Tool

- Non-marring wedge has a 1" blade with a curved clip end that allows easy access and removal of plastic bezels, mouldings, trim and panels without scratching the surface
- Non-marring, won't scratch paint
- Great for removing weather stripping

BODY SHEET METAL



HSA9850D

UNI-Spotter Aluminum + Steel Repair Station

- All in one repair station
- All tips and consumables for steel, aluminum, and paintless
- The only station that offers steel and aluminum
- The best repair system on the market
- Same price with double the capability of competitors

The 9850D repair station gives the body man a system that they can rely on for any repair. The 9850D offers a complete system that allows for repair on steel and aluminum for welding and paintless dent repair for smaller repairs. Since the system can be used on any material the customer gets a return on investment from day 1. There is never a time where this system can not be used for a repair. This system provides all the tips and consumables for steel, aluminum, and paintless repair.



CAR CARE



WAGC900054

Wagner AutoRight SteamMachine

- Chemical-free way to make a car look brand new again
- Uses pressurized, high-temperature steam to loosen and dissolve dirt, cut grease and grime, expel stains and sanitize your surface killing 99% of bacteria.
- Includes 11 attachments
- Once the AutoRight SteamMachine is turned on and water is added, the unit takes approximately 8 minutes to build pressure and heat up.
- The steam allows deep dirt and grime to release. The included microfiber towel can then be used to wipe away the dirty residue so that you're left with a shining, new surface.
- 2 year warranty on material and workmanship



CAR CARE

Car Wash Products



MEGG17748

Ultimate Wash & Wax, 48 oz

- Leaves a deep, glossy, just-waxed shine
- Carnauba and synthetic polymer technology in our most premium wash
- Incredible sudsing action safely lifts dirt and grime



MEGG7164

Gold Class Car Wash Shampoo and Conditioner, 64 oz Bottle

- Rich and luxurious car wash designed to both gently wash and condition paint in one easy step
- Rich suds that gently and safely foams away tough dirt, road grime, and contaminants
- Safe on all paint types and will not compromise wax protection



MEGG10464

Deep Crystal® Car Wash

- Ideal for detailers
- An excellent way to extend the life of a vehicle
- Protects wax and preserves finish



MEGM6201

Carwash Shampoo and Conditioner - 1 Gallon

- Ultra high foaming, non-streaking formula and it's Ph balanced
- Safe for use in the paint shop
- Contains conditioning agents and paint nutrients to provide sparkling streak-free results



MEGG3626

Wash Anywhere Spray

- Safely wash and wax your car anywhere, without water
- Safely cleans more dirt than a detailer
- Leaves hydrophobic wax protection

MEGA3316

Quick Detailer Mist & Wipe 16oz.

- Meguiar's Quik Detailer removes dust, fingerprints & harmful contaminants like water spots & bird droppings, before they damage your finish
- Keeps a waxed car looking "just waxed"



MEGG14422

Meguiar's Ultimate Detailer

- Safely removes dust and surface contaminants in-between washing
- Hydrophobic Polymer Technology darkens finish, adds protection & water beading
- This gentle formula is safe on all paint types



MEGM14016

Ultimate Quik Wax (16 oz.)

- Mist on...wipe off...effortlessly
- Can be applied in direct sunlight
- Deep, wet look shine



Final Inspection® Detailer

- A fast, mist-on, wipe-off detailer for a "Show Car Shine"
- Use to evaluate paint repairs, or to look for surface defects
- Ideal for use before customer delivery
- Made for professionals

MEGM3401 - 1 Gallon

MEGM3416 - 16 oz.

CAR CARE

Car Wash Products



MEGA3714 Water Spot Remover

- Quickly removes water spots without damaging your vehicles clear coat
- Use on paint, glass, chrome & hard plastic
- Can be used by hand or with dual action polisher



MEGM4716 Marine/RV Hard Water Spot Remover - 16 oz.

- Thick low drip formula remains on vertical surfaces for easy cleaning
- New technology chemically embraces and lifts mineral deposits and protects surface from future water spots
- Removes tough hard water spots
- Protects surface from future water spots



FTZFM11506 Flat/Matte Finish Cleaner (16 oz.)

- Safe for use on flat & matte paint finishes and vinyl wraps- cars, trucks, motorcycles, tubs, sinks, faucets, toolboxes & more
- Removes fingerprints, bird droppings, bugs, wax residue, soap scum, water stains, oils, lotions & more
- Will NOT leave a shine
- Does NOT contain wax or fillers



MOM05600 California Gold Car Wash, 16 oz Bottle

- We created Car Wash with a careful balance of powerful cleaning and exacting care
- Now you can wash your car thoroughly while protecting your wax
- It's not just about bubbles - various dishwashing liquids and "soaps" can harm your wax
- Our Car Wash is strong enough to wash away dirt, road film, bugs, bird droppings, airborne pollutants and other grime, without removing wax or dulling the paint



MOM85624 Professional Instant Detailer, 24 oz Spray Bottle

- Silicone-free, body shop safe, paintable product that provides unparalleled depth and clarity
- This unique formula is easy-to-use and completely safe on all types of paints, including clearcoats
- Simply the fastest way to prep and shine any vehicle's paint in any body shop environment



MOM08216 California Gold Showtime Instant Detailer, 16 oz Spray Bottle, with Color Enhancers

- The original Showtime® formula you've come to know and trust, with a fresh new name and look
- Quick touch-ups and maintenance between washings have never been easier
- Great for all types of paint, including clearcoats
- Add depth and clarity in seconds while removing surface dirt and debris, it's that easy!



PAINT & BODY | tools

WIZ99004

7 Piece Wizards® Detailing Cool Kit

- 22oz Mist and Shine professional detailer
- 22oz Tire and Vinyl Shine
- 4" applicator pad
- 22oz Power Clean
- 16oz Shine Master
- 16oz Wizards Wash
- Multi fiber detail cloth
- FREE Wizards can koozie
- FREE Wizards mini LED flashlight
- All packed into a soft sided cooler



CAR CARE

Car Wash Products



Bug Release™ All Surface Bug Remover

- Quickly removes bugs and residue
- Neutralizes acidic bug proteins
- Safe for all vehicles' paint, chrome, glass and plastics
- Non Toxic — biodegradable
- Use as a presoak or spot cleaner

WIZ11081 - 22 oz Bottle

WIZ11082 - 1 Gallon



Wizards® Wash Super Concentrated

- Thick, rich, long-lasting foam
- Gentle, but thorough, cleaning on all types of exterior vehicle surfaces
- Streak-free rinsing assures quick drying and maximum shine without stripping Shine Master™ Polish & Breathable Sealant
- Adds lubrication when wet sanding
- Marine use: To wash and pre-clean exterior of boat

WIZ11077 - 16 oz Bottle

WIZ11079 - 1 Gallon



Mist-N-Shine Professional Detailer

- Brightens all paint, clear coat, fiberglass and chrome
- Perfect to use between complete wax applications
- Safe for fresh paint, show chrome and Lexan
- Hides swirls, will not scratch* or streak*, even in direct sun
- Anti-static, perfect for spot cleaning or "dry washing" to remove dust, bugs, oily fingerprints and more
- Contains no wax or petroleum solvents

WIZ01214 - 22 oz Bottle

WIZ01217 - 1 Gallon



WIZ01227

1 Gallon Bottle Wipe Down Matte Paint Detailer

- Removes oily residue after buffing
- Removes streaks and smears from over use of waxes and glazes
- Removes dust, fingerprints, road grime and oily residue without adding gloss
- Eliminates missed areas masked by buffing residue
- Contains no wax, solvents or silicone
- Safe for all paint systems
- Adds no gloss or protection
- Adds no gloss or protection, contains no wax, solvents or silicone



WIZ01235

Mystic Spray Wax Slick Finish Detailer - 22oz Spray Bottle

- Synthetic spray wax technology far beyond outdated carnauba waxes
- Outstanding gloss, clarity, depth, slickness and durability
- Performs excellently on all paint types including today's advanced clears



WIZ66309

Black Renew™ Exterior Treatment, 8 oz Bottle

- Works on all colors of exterior trim
- Instantly removes embedded wax and compound from textured body side moldings
- Cleans and renews faded trim
- Concentrated cream outlasts sprays
- No airborne silicone contaminants

CAR CARE

Wheel & Tire Products



MEGG13815
Hot Shine™ High Gloss Tire Coating (15 oz.)

- Hot Shine's™ high gloss formula gives your tires a "wet-look" with a dark shine
- By combining highly water-resistant polymers with antiozonant technology, Hot Shine keeps your tires looking blacker longer while preventing cracking, browning and premature aging



MEGD14001
D140 Detailer, Wheel Brightener™, 1 Gallon

- Safe on clear coated, factory painted, & chrome wheels
- Easily removes brake dust
- Concentrated formula 4:1
- Not safe for polished aluminum



MEGG19124
Hot Rims™ Chrome Wheel Cleaner

- Our Xtreme Cling™ foam is designed to cling vigorously to vertical surfaces and dissolve anything between your chrome and a brilliant "mirror-like" shine!
- Removes grime, grit and brake dust from chrome
- Provides a mirror like finish



MEGG13919
Hot Shine Tire Foam (15 oz.)

- Clean, shine & protect your tires in one easy step
- Powers through build-up to reveal a deep black shine
- Simply spray and walk away
- The thick, active foam clings to tires, dissolving away build-up



MEGG13115
NXT Generation® Insane Shine Tire Coating, High Gloss Tire Dressing (15 oz.)

- Just spray and walk away
- High gloss for tires - a deep, dark, "insane" wet look that is fast and easy
- Mirror-like shine that prevents browning & premature aging



MEGG15415
Endurance Aerosol (15 oz.)

- Hot Shine's™ high gloss formula gives your tires a "wet-look" with a dark shine
- By combining highly water-resistant polymers with antiozonant technology, Hot Shine keeps your tires looking blacker longer while preventing cracking, browning and premature aging



MEGG12024
Hot Shine™ Tire Gloss (24oz.)

- High gloss formula gives your tires a "wet-look" with a dark shine
- Highly water-resistant polymers combined with anti-ozonant technology keep tires looking blacker longer, while preventing cracking, browning, and premature aging



MEGG9524
Hot Rims® All Wheels® Cleaner

- Removes stubborn road residue with unique foaming agents
- Our Xtreme Cling™ foam is designed to cling to vertical surfaces and break down stubborn road residue between your wheels
- Safe for all factory, clear-coated and painted wheels



MEGD16332
Rim & Tire Gel (32 oz.)

- Provides deep satin black look
- Thick consistency, no runs, drips, or overspray
- Long lasting, non-streaking formula



Tire and Vinyl Shine™ Dressing and Protectant

- Beautifies vinyl, leather, rubber, plastic, exterior and interior trim and more
- Non-greasy, non-slippery
- Anti-static, forms a dry shield to protect surface



WIZ11055 - 22 oz Bottle



MOM05924
Foaming Wheel and Tire Cleaner (24 oz.)

- Foaming, non-acidic spray, formulated to quickly and easily clean both wheels and tires, including blackwalls and whitewalls
- Safe for original equipment wheels and hubcaps
- Dissolves and suspends all types of brake dust, grease, dirt, and grime - making rinsing a snap



MOM05824
Pro-Strength Chrome Wheel Cleaner (24 oz.)

- Specially formulated to quickly and easily clean chrome wire wheels, chrome plated wheels, hubcaps and rough cast aluminum "mag" wheels
- Dissolves and suspends all types of brake dust, grease, dirt, and grime—making rinsing a snap



CAR CARE

Leather and Vinyl Products



MEGM4001
Pro Vinyl and Rubber Cleaner/Conditioner (1 Gallon)

- Cleans, penetrates and rejuvenates vinyl and rubber surfaces
- Durable protection that screens out damaging UV rays
- Restores life and color
- Leaves a rich, natural sheen, unlike the shiny synthetic coating of simple protectants

MEGM4016
Pro Vinyl and Rubber Cleaner/Conditioner - 16 oz.



MEGD18001
Leather Cleaner and Conditioner (1 Gallon Bottle)

- Non-staining formula
- Restores "like new" look
- Colorless with a pleasant citrus fragrance

MEGG7214
Gold Class™ Rich Leather Cleaner/Conditioner - 14 oz.

- This luxurious, pH balanced one-step treatment safely cleans and protects fine leather without using harmful or harsh solvents
- Mild cleaners provide a safe cleaning action without stripping nutrients or protection
- Special oils moisturize and condition leather so it remains rich and supple without adding artificial slickness



MEGG4000
Supreme Shine® Protectant Wipes

- For those who love shine, Supreme Shine Protectant is the fastest and easiest way to create a hi-shine surface on vinyl, rubber, and plastic surfaces
- Superior hi-shine protection to preserve vinyl, rubber & plastic
- Non-greasy formula cleans, shines & protects

MEGG14716
Ultimate Protectant (16oz)

- For superior UV protection & shine on rubber, vinyl & plastic
- Utilizing break-thru UV clear coat technology



MEGD4510
Detailer Vinyl and Plastic Coating, 10 oz

- Ideal for exterior & interior use
- Restores & protects
- Fast drying, instant shine
- Easy residue wipe-off from glass & paint



MEGG15812
Ultimate Black

- Restore new life to all exterior plastic, vinyl & rubber trim such as bumpers, moldings, door handles, rearview mirror housings & windshield cowlings
- Utilizing breakthrough UV clear-coat technology, Meguiar's® Ultimate Black significantly outlasts conventional protectants & trim-care products



MEGG13600
Quik Interior Detailer™ Wipes

- Fast interior touch-ups are now simple and easy
- Use daily to maintain a clean appearance and every time you wash or Quik Detail for that complete "just detailed" look
- Safely cleans ALL interior surfaces
- Improved, deeper cleaning formula

MEGM3916
Heavy Duty Vinyl Cleaner (16 oz.)

- Tough cleaner that removes heavy dirt and grime
- Great for cleaning and prepping all vinyl, plastic, rubber and urethane surfaces
- Apply to vinyl tops, bumpers, plastic door panels, car and boat interiors, luggage and furniture



MOM06412
Leather Cleaner, 12 oz Spray Bottle

- The perfect, smooth leather cleaner
- High-traffic leather interiors, convertibles with leather and essentially every other smooth leather should be bathed regularly - it's a natural skin and needs care
- Our chemists created Mothers® Leather Cleaner, a pH balanced formula that safely lifts impregnated dirt, grime and stains from your precious leather interior



CAR CARE

Waxes & Polishes



**MEGM6601
Professional Quick
Detailer - 1 Gallon**

- One step cleaner/wax
- Aggressive cutting action
- Quickly and safely removes oxidation and blemishes
- Restores deep gloss and provides a durable wax finish



**MEGM2064
Mirror Glaze®
Polymer Sealant, 64 oz.**

- Unique blend of polymers, resins, silicones and imported waxes that create a brilliant high gloss finish that outlasts all other traditional waxes
- Safe and effective on all paint finishes, including clear coats



HiTech Yellow Wax

- Premium yellow Carnuba wax blended with silicones, polymers and other waxes
- Adds richness and depth of color
- Provides ultimate high-gloss protection to any previously cleaned and polished paint finish

MEGM2611 - 11 oz. Paste
MEGM2616 - 16 oz. Liquid



Machine Glaze

- Outshines all other machine applied polishes, glazes, waxes and sealants
- Penetrating nutrients revitalize all paint finishes
- Buffing residue wipes off easily
- Restores original brilliance and clarity
- Safe and effective on fiberglass, plastic and paint

MEGM0316 - 16 oz.
MEGM0364 - 64 oz.



Mirror Glaze® Liquid Cleaner Wax

- Cleaner/Wax's one-step application cleans, polishes and protects
- Apply by hand or machine to remove light oxidation and create a long lasting, high gloss finish

MEGM0616 - 16 oz.
MEGM0664 - 64 oz.



**MEGM2601
Mirror Glaze® Hi-Tech Yellow Wax
1 Gallon**

- Premium yellow Carnuba wax blended with silicones, polymers and other waxes
- Adds richness and depth of color
- Provides ultimate high gloss protection to any previously cleaned and polished paint finish

**MEGM2116
Mirror Glaze Synthetic
Sealant 2.0 Wax (16 oz.)**

- Hydrophobic Polymer Technology™ provides amazing gloss and water beading
- Produces a noticeable deeper, darker, more reflective paint finish



**MEGM0716
Show Car Glaze - 16 oz.**

- Show Car Glaze outshines all other hand applied polishes, glazes, waxes and sealants
- Restores a dazzling, deep, wet shine
- Does not dry white and is safe and effective on all paint finishes



**MEGM2016
Mirror Glaze® Pro
Polymer Sealant - 16 oz.**

- Unique blend of polymers, resins, silicones and imported waxes that create a brilliant high gloss finish that outlasts all other traditional waxes
- Safe and effective on all paint finishes, including clear coats



CAR CARE

Waxes & Polishes



**MEGG17516
Ultimate Quik Wax®**

- Synthetic, non-whitening formula produces amazing results in just minutes
- Features Hydrophobic Polymer Technology™, making paint come alive with a deep, wet-look shine you would only expect from liquid or paste waxes

**MEGA1216
Cleaner Wax Liquid (16 oz.)**

- Meguiar's® versatile, one step wax specially formulated to produce eye-dazzling results on all finishes
- Rich conditioning oils with gentle cleaning ability make it an excellent choice for daily drivers exposed to the elements
- Cleans your paint while you wax
- Rich conditioning oils polish & protect



**MEGA2216
Deep Crystal® Carnauba Liquid Wax (16 oz.)**

- Creates a strong, protective wax barrier on your paint that locks in shine and gloss
- This tried-and-true formulation utilizes high grade carnauba to protect all paint surfaces, including clear coats
- The highest grade of carnauba to protect all paint surfaces
- Creates a protective barrier on paint that locks in shine & gloss



**MEGM0811
Meguiar's Maximum Mold Release Wax**

- Blend of imported waxes specially formulated to provide the maximum number of releases per application
- For fiberglass applications



DA Microfiber Finishing Wax

- One-pass fast, dust-free wipe off
- Rich blend of polymers, silicones and carnauba for high gloss protection
- Specially formulated to optimize surface after applying Meguiar's® DA Microfiber Correction Compound
- Meguiar's® DA Microfiber Finishing Wax may be applied to entire vehicle prior to wipe off
- Non-caustic, fragrant formula

**MEGD30101 - 1 Gallon
MEGD30116 - 16 oz**

**MEGA1214
Cleaner Wax - Paste**

- Cleans your paint while you wax
- Rich conditioning oils polish & protect



**MEGG18216
Ultimate Liquid Wax 16oz**

- Meguiar's® ThinFilm technology delivers our easiest application and removal even if you have to wax in full sun!



**MEGG18211
Ultimate Paste Wax (11 oz.)**

- Meguiar's® ThinFilm technology delivers our easiest application & removal even if you have to wax in full sun!
- Cross-linking synthetic polymers form our longest lasting protective barrier, amplifying reflections for incredible depth & mirror-like shine



**MEGG7014
Gold Class™ Carnauba Plus Paste Wax**

- Regardless of what paint you have, this wax will dramatically darken the color, bringing out the full richness of the paint
- Creates clear, sharp reflections unlike anything you've ever experienced
- Glides on and off so easily that you will want to wax more often
- For best results, apply with an Even-Coat Applicator and remove the residue with a Supreme Shine® Microfiber or Ultra Plush Super Terry

**MEGG6207
Black Wax (7 oz.)**

- Specially formulated for dark to black colors
- Polishes while you wax for incredible depth
- Add gloss while leaving swirl free results
- Synthetic Polymers provide long lasting, durable, protection



**MEGM4916
Marine/RV Heavy Duty Oxidation Remover (16 oz.)**

- Removes moderate oxidation, scratches, stains and tough water spots on all fiberglass gel coat marine or RV surfaces
- Restores color by effectively removing surface degradation



CAR CARE

Waxes & Polishes



Meguiar's Marine Boat/RV Cleaner Wax One Step

- Non-abrasive formula quickly cleans, polishes, and protects all fiberglass gel coat marine or RV surfaces
- Safely and effectively removes light oxidation, haze, minor scratches and swirls
- Provides durable long-lasting protection against salt air, corrosion and the sun's ultraviolet rays

MEGM5014 - Paste 14oz
MEGM5016 - Liquid 16oz
MEGM5032 - Liquid 32oz

Meguiar's White Wax - 7 oz

- Specially formulated for light to white colors
- Removes light oxidation and contaminants
- Micro cleaners restore paint brightness
- Synthetic Polymers provide long lasting, durable, protection



Meguiar's Flagship Premium Cleaner/Wax (32 oz.)

- Effortlessly removes light to moderate below surface defects like oxidation, water spots, minor scratches, swirls, haze, and more
- Adds a brilliant gloss, amazing shine, and provide long lasting superior protection against salt air corrosion and the sun's devastating ultraviolet rays
- Safe and effective on fiberglass, painted, and gel coat surfaces of any color, and can be used in direct sunlight



Meguiar's MEGM8301 Dual Action Cleaner / Polish 1 Gallon

- A moderate abrasive that has the power to remove light to medium contamination
- Combines the perfect amount of abrasive cleaner and pure, rich polish to produce a customer pleasing deep gloss shine
- Removes defects without marring the finish



Meguiar's MEGM20508 Mirror Glaze Ultra Finishing Polish (8 oz.)



Meguiar's MEGM6332 Flagship Premium Marine Wax (32 oz.)

- Dramatically enriches color and shine of fiberglass and gel coat surfaces
- Effective in removing light oxidation and dullness, restoring gloss, and adding protection from UV damage
- Use wax only after the surface has been cleaned and restored to a "like new" or "average" finish



Meguiar's MEGD30132 DA Microfiber Finishing Wax

- One-pass fast, dust-free wipe off
- Rich blend of polymers, silicones and carnauba for high gloss protection
- Specially formulated to optimize surface after applying DA microfiber correction compound



Meguiar's MEGM8332 Body Shop Professional Dual Action Cleaner / Polish (16 oz.)

- It's a moderate abrasive that has the power to remove light to medium contamination
- High performance polish eliminates swirl marks and removes fine scratches
- Enriches gloss and color with machine or hand application



Meguiar's MEGM20532 Mirror Glaze® Ultra Finishing Polish (32 oz.)

- Permanently removes swirls & light defects from all paints
- Produces deep reflections & high gloss
- Smooth buffing feel and fast wipe-off
- Advanced Technology / formula produces a deep gloss and rich, swirl-free results



Meguiar's MEGM8232 Body Shop Professional Swirl Free Polish (32 oz.)

- Meguiar's Speed Glaze is a shortcut that cleans, polishes and protects in one simple step
- High performance polish eliminates swirl marks and removes fine scratches
- Enriches gloss and color with machine or hand application
- Speed Glaze is safe and effective on any kind of paint finish, including clear coats



Meguiar's MEGM8632 Solo® One Liquid System Cut and Polish Cream (Quart)

- Simple, one liquid system for both compounding and polishing
- Advanced Unigrit technology delivers level cutting and swirl-free polishing
- Specifically designed for paint and body shops



CAR CARE

Waxes & Polishes



MEGM20501 Meguiar's Ultra Finishing Polish 1 Gallon

- Contains Meguiar's Super Micro Abrasive Technology to cut fast and leave a smooth finish in less time
- Use it as a finishing polish or as a light swirl remover on all types of paint
- It is safe for use in a paint shop environment and contains no crystalline silica



MEGM0916 Swirl Remover (16 oz.)

- Removes fine scratches and swirl marks, while providing a dark dramatic shine
- Formulated to reduce spatter and make application and wipe-down easier



MEGM1008 Clear Plastic Polish (8 oz.)

- Safely restores optic clarity to all clear plastics
- Provides a static free coating that repels dust
- Safe and effective on both acrylic and polycarbonate surfaces
- Ideal for boots, RV's, cars, motorcycles and aircraft



MEGM1708 Mirror Glaze® Clear Plastic Cleaner (8 oz.)

- Removes fine hairline scratches
- Unique, non-abrasive formula
- Prepares surface for Clear Plastic Polish



MEGM1808 Mirror Glaze® Clear Plastic Detailer (8 oz.)

- Quick spray and wipe for all clear plastics
- Removes smudges and residue without scratching
- Anti-static/non-hazing



MEGM14116 Teak Cleaner



MEGG12310 PlastX Clear Plastic Cleaner and Polish (10 oz.)

- Easy to use, rich gel formula quickly restores optical clarity to both rigid and flexible clear plastics
- Meguiar's exclusive Microscopic Diminishing Abrasive™ Technology removes light oxidation, chemical degradation, surface contamination, stains, and light surface scratches



MEGG10307 ScratchX® 2.0 Fine Scratch and Blemish Remover (7 oz.)

- The most effective way to safely remove fine scratches and swirls, now by hand or with a dual action polisher
- Uses diminishing abrasive™ technology to safely and effectively remove fine scratches, swirls, and oxidation



MEGDMCKIT6 DA Microfiber Correction System Kit (6")

- A complete solution in a box to address today's No. 1 complaint among vehicle owners: swirls



Kit includes:
 2 DA Microfiber Cutting Discs
 2 DA Microfiber Finishing Discs
 Backing Plate, DA Microfiber Correction Compound – 16 oz.
 DA Microfiber Finishing Wax – 16 oz.
 Free Meguiar's Black Apron



MEGG17616 SwirlX®

- Removes swirl marks, spider webs, holograms to restore crystal clear reflections and have a flawless, show-car shine
- Effortlessly Removes Swirl Marks
- Safe to use on Clear Coat Surfaces



3M™ Perfect-It™ Machine Polish

- Quickly and effectively removes compound swirl marks and produces an outstanding finish
- Good handling, easy clean up

MMM6065 - 1 Gallon



MMM6069 3M™ Perfect-It™ Ultrafine Machine Polish, 1 Gallon

- Unique formula eliminates swirl marks and produces a high gloss finish, even on the most difficult dark colored vehicles
- Good handling, easy cleanup

CAR CARE

Waxes & Polishes



MMM5928 3M™ Finesse-It™ II Glaze, 1 Quart

- Designed for use on OEM and fully cured automotive paints
- Can remove grade microfine 1500 sand scratches
- Removes swirl marks after compounding while leaving a glazed finish
- VOC content less than 17%



MMM5990 3M™ Imperial™ Hand Glaze - 1 Quart

- Recommended for use by hand to increase surface gloss and to clean up spatter or residue after machine glazing all types of refinish or factory applied automotive paints
- It is used by hand to refine and fill swirl marks after machine glazing
- Non-silicone, non wax hand glaze
- Has been formulated to work on all colors and can be painted over



MMM08852 3M™ Cavity Wax Plus (18.7 oz.)

- An interior corrosion preventative coating for direct application to automotive bare or primed metals
- Typical areas of applications are door skins
- Typical areas of applications are rocker panels, interior quarter panels



MMM08851 3M™ Cavity Wax Plus Applicator Wand Kit

- A reusable multi length method to apply 3M™ Cavity Wax Plus
- Apply 3M™ Cavity Wax into hard to reach areas
- Uses specialized tips which provides a 360 degree or 180 degree spray pattern

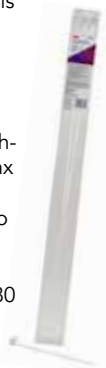

FTZBP03511 Flitz Metal, Plastic and Fiberglass Polish 1.76 oz Tube

- Cleans, polishes, protects all metals, painted surfaces, plastics and fiberglass
- Removes oxidation, tarnish, rust, water stains, heat discoloration, lead and powder residue, scuff marks and more
- Small amount of product goes a very long way - the 1.76 oz tube covers 200 square feet
- Eco-friendly, non-toxic
- Easy to use cream formula

FTZBU03515 Flitz Polish Paste - 5.29oz

- A concentrated cream, unsurpassed in its ability to clean, polish, deoxidize and protect
- Tough, durable protection
- Non-abrasive formula
- Non-toxic, non-flammable, USDA authorized
- Protects up to 6 months in fresh water, up to 3 months in salt water



FTZCA03518-6 Metal Polish Can - 2lbs

- Metal, Plastic and Fiberglass Polish



Green Metal, Plastic and Fiberglass Polish Liquid

- Cream formula, non-toxic
 - Safe for cleaning, polishing and protecting all metals, fiberglass, plastics and painted surfaces
 - Removes oxidation, tarnish, rust, water stains, heat discoloration, lead and powder residue, scuff marks and much more
 - This premium is for all purpose polish and cleaner
- FTZLQ04535 - 3.4 oz. Bottle**
FTZLQ04587 - 7.6 oz. Bottle



MOM05101 Mag and Aluminum Polish - 10 oz Jar

- Mothers Mag & Aluminum Polish is a secret formula that balances a brilliant shine with easy use
- While originally designed for polishing wheels made of magnesium such as those made by Minilite and Halibrand, Mag & Aluminum Polish can be used on billet aluminum wheels, valve covers, exhaust tips and all polishable metal accessories
- NOTE: Mothers Mag & Aluminum Polish is significantly more aggressive than Mothers Billet Metal Polish. If you're polishing modern, billet aluminum wheels, we recommend you use Mothers Billet Metal Polish

CAR CARE

Waxes & Polishes

MOTHERS

California Gold Brazilian Carnauba Cleaner Wax

- Designed to be the one-step plan for paint preservation
- Cleaner Wax is formulated to clean and protect in just one application
- We use the same Brazilian #1 yellow carnauba that makes our Pure Brazilian Carnauba Wax so special, and combine it with a light polish that will smooth minor flaws and make your paint snap
- Brazilian Carnauba Cleaner Wax is especially effective on fiberglass and gel coats

MOM05701 - 16 oz liquid



MOM82332 Professional Machine Glaze, 32 oz Bottle

- High-quality polishing glaze that quickly removes compound haze, fine scratches and swirl marks from all types of refinish or factory applied automotive paints



MOM05724 California Gold Spray Wax (24 oz.)

- Quick and easy way to clean, shine and protect any automotive paint, including clearcoats
- Spray Wax removes surface dust and fingerprints, while adding long-lasting shine, luster and depth
- Used on a wet or dry surface, Spray Wax works as a booster over your existing wax, or as a stand-alone product. Simply spray, wipe and buff to a brilliant shine



MOTHERS

MOM05750 California Gold Pure Brazilian Carnauba Liquid Wax (16 oz.)

- The finishing touch to our Ultimate Wax System®, delivering deep shine and lasting protection for all paints and clearcoats
- While Steps 1 & 2 clean and smooth the surface of your paint for the ultimate in reflectivity, this final step in our process enhances and preserves the finish of your vehicle, and delivers the richness and depth you deserve



MOM07100 California Gold Pure Polish, 16 oz Bottle

- The foundation of our three-step Ultimate Wax System®, restoring color and brilliance by removing oxidation, contaminants, micro-scratches, swirls, water spots, and other blemishes from your paint or clearcoat
- This initial step deep cleans the surface of your vehicle, paving the way for a final micro-polish and finishing wax, creating the ultimate shine



MOM20016 FX Engineered SynWax (16 oz.)

- Designed to give your paint uncompromising protection while providing unequalled shine and ease of use
- Engineered encapsulation process allows for effortless prep so the wax spreads quickly and easily
- Removal is a breeze, leaving behind super-tough and engineered polymers that bond to your paint
- Provides depth, richness, and advanced protection against harmful UV damage and other environmental concerns



MOTHERS

MOM08100 California Gold Micro-Polishing Glaze, (16 oz.)

- Adds vibrance, depth and clarity to all paints and clearcoats, creating the ultimate in flawless reflectivity, especially on dark colors
- This central step of our Ultimate Wax System® brings together the deep cleaning restoration of our Step 1 Pure Polish and the protective finishing touch of our Step 3 Pure Brazilian Carnauba Wax, creating the ultimate shine



MOM83432 Professional Foam Pad Polish, 32 oz Bottle

- Recommended for removal of compounding swirl marks from all types of refinish or factory applied automotive paints
- Also recommended to enhance color and add depth



SEM



SEM40482 Bumper Bite Flexible Glaze

- Extremely flexible for enhanced resistance against cracking
- Fast drying to a tack-free finish
- Superior sanding qualities extend life of sandpaper
- Can be applied over properly prepped OE paint
- Excellent adhesion

WARNING: Cancer and Reproductive Harm - www.P65Warnings.ca.gov

CAR CARE

Waxes & Polishes



WIZ11020
Metal Renew™ Liquid Polish for All Metals (8 oz.)

- Brightens and renews aluminum, brass, stainless steel, chrome* and more
- Fast cut, high gloss
- Creamy emulsion does not require constant shaking



WIZ11011
Metal Polish The Magic Is In The Cloth (3 oz.)

- Brightens and protects ALL metals: aluminum, chrome*, stainless, brass, copper, nickel, etc.
- Fast cutting, highest gloss possible
- Removes tarnish, corrosion, oxidation, brake dust and tar
- Safe for coated wheels, motorcycles, and household applications
- Marine use; on polished metals, rails, handles, tie ups, moldings



Shine Master™ Polish and Breathable Sealant

- No streaks or smears
- No free silicone or wax
- Cleaning/tough poly acrylic protection
- Safe for fresh paint, clear coat and Lexan
- Use as a wax replacement, swirl mark remover, or finishing (show) glaze by hand or machine
- Marine use: exterior sealant on gelcoat, paint or fresh paint

WIZ11033 - 16 oz Bottle
WIZ11035 - 4 oz Bottle
WIZ11036 - 1 Gallon

WIZ11099
4 Piece Metal Buff Kit

- 1 Each of Part No. 11091, 11092, 11093, 11094 Buffs
- Use with WIZARDS® Metal Renew™ for fast, effective, power polishing. ¼" shank fits electric or air drills
- Part No. 11091, Mushroom Buff, 3" (approx.) diameter



Shine Master™ Polish & Breathable Sealant

- No streaks or smears
- No free silicone or wax
- Tough, long-lasting poly-acrylic protection
- Safe for fresh paints, clear coat and Lexan
- Use as a wax replacement, swirl mark remover, or finishing (show) glaze



WIZ11047
Mystic Polish Machine Glaze - 32 oz Bottle

- Exclusive "Nano-Sphere Technology" incorporates latest Nano abrasives
- Quickly removes swirls, light scratches, spider webbing and mild imperfections
- No wax, silicone or crystalline silica
- Safe for all paints



WIZ11033 - 16 oz Bottle

Compounds



RUP9.BFKERAMIK250-6
Big Foot Fine Compound Keramik Gel 250 ml / 1 Carton of Six Bottles

- This fine water-soluble abrasive compound is ideal for totally eliminating paint defects and for a hologram-free final step of spot repair, following the microabrasive nib removal process
- Also suitable for clear and particularly hard surfaces
- For best results is suggested to use Gel compound with RUPES FINE and ULTRA FINE polishing foam for random orbital polisher



RUP9.BFZEPHIR1000-8
Big Foot Coarse Compound Gel ZEPHIR 1000 ml / 1 Carton of Eight Bottles

- High-performance compound recommended for first step polishing
- Its grain is the most "aggressive" of the BigFoot abrasives and is used for the rapid removal of marks and scratches
- At the same time Zephir is highly effective in restoring paints and creating a high degree of gloss
- Simplifies the removal of marks produced by grains down to P1500

CAR CARE

Compounds



MEGDMCKIT6 DA Microfiber Correction System Kit 6"

- A complete solution in a box to address today's No. 1 complaint among vehicle owners: *swirls*
- With Meguiar's® 6" DA Microfiber Correction System, technicians will deliver a swirl free finish, Guaranteed!

Kit includes: 2 ea. DA Microfiber Cutting Discs, 2 ea. DA Microfiber Finishing Discs, Backing Plate, DA Microfiber Correction Compound – 16oz., DA Microfiber Finishing Wax – 16oz. and a Free Meguiar's Black Apron



DA Microfiber Correction Compound

- No swirls- GUARANTEED
- Super-micro abrasive technology quickly removes moderate defects with a high gloss
- No mess, no sling, low dusting for superior clean up

MEGD30016 - 16 oz.
MEGD30001 - Gallon



MEGG17216 Ultimate Compound

- Safely restore color and clarity to abused and neglected finishes with Meguiar's® Ultimate Compound
- Cuts fast and removes swirl marks, without scratching paint surface
- Use by hand or with a DA Polisher



MEGM10532 Mirror Glaze® Ultra-Cut Compound, 32 oz

- Exclusive, super-micro abrasive technology
- Ultra fast cutting removes 1200 grit or finer sanding marks
- Also great for removing scratches, defects, acid rain and severe swirls/holograms



MEGM10501 Ultra-Cut Compound, Mirror Glaze 105, 1 Gallon Bottle

MEGM8532 Diamond Cut Compound® - 16 oz.

- Low-dusting, low splatter formula
- A super fast low swirl compound
- A must for high solid paint



MEGM8401 Compound Power Cleaner - 1 Gallon

- Contains aggressive abrasives that boost cleaning power and efficiency
- Quickly removes Meguiar's Unigrit 1200 grit sanding marks



MEGM0116 Medium Cut Cleaner-16 oz.

- Moderately abrasive cleaner that removes medium defects, including swirls, water spots and water sanding marks
- Diminishing Abrasives™ cut quickly, then reduce to a polishing rouge, while Buffered Abrasive™ action lubricates the finish to prevent scratching



MEGM0416 Heavy Cut Abrasive Cleaner - 16 oz.

- Removes deep swirl marks, scratches and severe oxidation, as well as etching from alkaline or acid rain
- For use with a rotary buffer only



MEGM0216 Fine Cut Mild Abrasive (16 oz.)

- For machine removal of stubborn paint defects



MEGM10032 Compound, Pro Speed (32 oz.)

- Fast cutting compound with advanced technology
- Quick removal of 1200 grit and finer sanding marks
- Removes deep scratches, acid rain, and severe swirls/holograms
- Works great on fresh and cured paints
- Formulated for use with a Rotary Buffer



MEGM6732 Marine One-Step Compound

- Removes moderate to heavy oxidation, scratches, stains and tough water spots
- Restores color and leaves a rich gloss on the treated surface
- Incredible results by hand or machine



MEGM8601 Solo™ One Liquid System Cut and Polish Cream - Gallon

- Simple, one liquid system for both compounding and polishing
- Advanced Unigrit® technology delivers level cutting and swirl-free polishing
- Safe, VOC compliant formula



CAR CARE

Compounds

3M

3M™ Super Duty Rubbing Compound

- Aggressive compound
- Remains wet on the job
- Maintains high rate of cut with constant pressure
- Buffs to high gloss with minimum of swirl marks
- Can be used by hand or machine

MMM5955 - 1 Gallon

MMM5954 - 1 Quart



MMM5973

3M™ Perfect-It™ II Rubbing Compound - 1 Quart

- Specially designed medium cutting, liquid compound for removing 1200, 1500, and 2000 color sanding scratches in automotive paints including clear coats
- Use with 3M™ Perfect-It™ Foam Compounding Pad, part number 05723



MMM6086

3M™ Perfect-It™ Rubbing Compound - 1 Gallon

- Fast cutting rubbing compound that removes sand scratches and leaves a fine finish on automotive paints
- Effectively removes grade P1200 and finer sand scratches
- Works on all types of automotive paints



MMM36061

1 Gallon Rubbing Compound

- Less sling and powdering
- Performs in all weather conditions
- Unique formula quickly removes P1200 grade and finer sand scratches and other surface defects



MMM5861

3M™ Dry Guide Coat Kit

- Includes 50 gram cartridge and applicator kit
- A method for identifying surface imperfections such as pinholes and deep scratches in primer
- Requires no masking and there is no dry time involved
- Can be used for both wet and dry sanding
- Contains no solvents



MOTHERS

Professional Rubbing Compound

- Quickly removes 1,500 grade and finer sand scratches from all types of refinish and factory applied automotive paints

MOM81132 - 32 oz Bottle

MOM81138 - 1 Gallon



Professional Heavy Duty Rubbing Compound

- Quickly removes 1,200 grade and finer sand scratches from all types of refinish and factory applied automotive paints

MOM81232 - 32 oz Bottle

MOM81238 - 1 Gallon



WIZARDS PRODUCTS

Finish Cut™ No Swirls Compound

- No swirls, easy clean up
- Levels 1200 grit or finer sand scratches
- One-step buffing on most colors and clear coat, fresh or aged finishes
- Brightens dull finishes, removes scratches and heavy paint overspray

WIZ11046 - 4 oz. Bottle

WIZ11040 - 32 oz. Bottle

WIZ11041 - 1 Gallon



Turbo Cut™ Time Release™ Compound

- Fast cut on dead paint, gelcoat and fiberglass
- Removes 1200 grit or finer sand scratches
- High gloss finishing on fresh or aged finishes, single stage paint and clear coat

WIZ11043 - 1 Gallon

WIZ11044 - 32 oz Bottle

WIZ11045 - 4 oz Bottle



Mystic Cut Nano-Sphere Technology Compound

- Exclusive Nano-Sphere Technology incorporates latest Nano abrasives
- Progressive cutting action with no grit
- Levels 1200-2000 grit sand scratches

WIZ11048 - 32 oz Bottle

WIZ11052 - 1 Gallon



CAR CARE

Dispensers & Strainers



MEGD9916
Dispenser Bottle 16 Oz



MEGM9911
Multi-Purpose Spray
Bottle with Trigger
Sprayer



MEGD20100
Bottle Only, Generic,
32 oz, OSHA Compliant

MEGX3003

Pro Grit Guard Bucket Strainer

- Reduces the risk of swirls when washing
- Prevents mitt contamination and prolongs soap life
- Fits in most 5 gallon buckets
- Comes in Meguiar's Gold Color!



MEGG16402

Air Re-Freshner New Car Scent

- Finds and permanently removes unwanted odor molecules
- Simple one time use aerosol makes it easy to refresh your vehicle
- Leaves a pleasant new car scent behind
- Uses car's recirculated air system to remove odors from hard-to-reach areas



All Purpose Cleaners and Degreasers



MEGD10101
D101 Detailer
All Purpose Cleaner, 1 Gallon

- Ideal for reconditioning most interior surfaces
- Active foaming action lifts dirt
- Fabric softeners enhance luxurious results

Meguiar's® All Purpose Cleaner is a versatile cleaner for both exterior and interior surfaces. Its superior foaming action gently lifts the dirt away from carpet, upholstery, vinyl and even leather.

MEGD20101
Bottle Only, for All Purpose Cleaner,
32 oz, OSHA Compliant



MEGD10801
D108 Detailer
Super Degreaser, 1 Gallon

- Strong & fast acting for the toughest jobs
- Residue-free performance
- Pleasant fragrance

Meguiar's® Super Degreaser exceeds expectations by quickly breaking down even the toughest grease. Its fast acting, free rinsing formula prevents unsightly white residue stains while its herbal fragrance creates a pleasant work environment.

MEGD20108
Bottle Only, for Super Degreaser,
32 oz, OSHA Compliant



CAR CARE

All Purpose Cleaners and Degreasers



FTZSP01506
Stainless Steel and Chrome Cleaner
with Degreasing Agents

- Water-based product
- Cuts through greasy build-up
- Streak free formula
- Will not attract dust
- Won't discolor stainless steel



WIZ11088
Power Clean™ All Purpose
Cleaner and Degreaser (22 oz.)

- Non-caustic, contains no acid
- Contains environmentally friendly surfactants
- Cleans tires and raised white letters
- Dissolves oil, road grime and brake dust
- Use as a grease, wax and silicone remover
- Marine use: For exterior algae removal, for interior seats, carpet and plastic cleaning



MMM6480
3M™ Hook and Loop Fastening System

- Premium performance adhesive system
- Comprised of two non-woven nylon strips, one of hook material and one of loop material
- Used for various applications in the automotive market

Scratch Remover



WIZ22049
Motorcycle Scratch Remover - 8 oz

- Levels minor scratches and swirls
- Removes light fading and blemishes
- Excellent pre-wax cleaner
- Safe on all paint, clears, and most plastics
- Hand or buffer application
- Safe alternative to harsh rubbing compounds



Chamois and Cloths



WIZ11066
Water Bandit™ All Purpose
Synthetic Chamois - 27" x 17"

- Absorbs 3 times faster than an ordinary leather chamois
- Soft and gentle, never lints and will not shed
- Unharmful by grease, oil or solvents; sensitive on paint
- Includes space-saving storage case
- Machine washable



WIZ11420
Multi-Fiber Detail Cloth, 16" x 24"

- Guaranteed to absorb faster than any terry towel, cotton cloth or paper towel
- Will not lint, streak, or scratch surfaces
- Can be washed by hand or machine hundreds of times with no performance loss

MOTORCYCLE CARE



WIZ22011 Metal Polish for Motorcycles (3 oz.)

- Fast cutting, highest gloss possible
- Brightens and protects all metals: aluminum, chrome, stainless, brass, copper, nickel
- Removes tarnish corrosion, oxidation, brake dust, and tar



WIZ22080 8 oz. Bug Release™ All Surface Bug Remover for Motorcycles

- Quickly removes bugs and bug residue
- Neutralizes acidic bug proteins so they can be easily washed away
- Safe for all motorcycle surfaces: paint, chrome, plastics, fiberglass and Lexan
- Non Toxic — biodegradable
- Use as a presoak or spot cleaner



Bike Wash Complete Bike Cleaner for Motorcycles

- Safe for paint, chrome, and plastics
- Foams away road grime, oil, grease, brake dust, and more
- Strong enough to degrease engines and wheels
- Cleans without spotting
- Biodegradable, ph controlled, no caustic soda, acids or bleach

WIZ22086 - 22 oz
WIZ22087 - 1 Gallon



BUFFING AND POLISHING

Polishers and Kits



MEGMT300 Meguiar's® Professional DA Polisher

- Wide OPM range, 3000-7500
- Optimized for compounding, polishing and waxing
- Digital Torque Management (DTM)
- Billet counter weight for smooth precision balance
- Replaceable brushes



AST3050 Complete Dual Action Polishing and Sanding Kit

- Kit includes: Pistol grip Dual action sander/polisher tool 2,800 rpm-13,000 rpm 1 - 3" Sanding/Polishing Back-up Pad 1 - 1-1/2" Velcro holder 1 - 1-1/2" Sanding pad 1 - 3" Polishing foam pad 2 - 3" 400 Grit sanding disc 2 - 3" 600 Grit sanding disc 2 - 3" 1000 Grit sanding disc 10 - 1-1/2" 2000 Grit sanding disc 2 Spanner wrenches



AST3055 3" Mini Air Polishing Kit

- 2,500 rpm
- Kit includes: 1 - 3" Mini Polisher (#3043), 1 - 3" Sanding /Polishing Back-up Pad (#20302P), 1 - 3" Wool Buffing Pad (#20303), 1 - 3" Polishing Foam Pad - Yellow (#20306), 1 - 3" Polishing Foam Pad - White (#20306W)



⚠️ **WARNING:** Cancer and Reproductive Harm - www.P65Warnings.ca.gov

⚠️ **WARNING:** Cancer and Reproductive Harm - www.P65Warnings.ca.gov

BUFFING AND POLISHING

Polish Kits



MEGG3500 DA Power System

- Having to do Car Care by hand can be a time consuming effort, but with Meguiar's® DA Power System; Compounding, Polishing and Waxing can be done in half the time. Essentially giving you more shine, in less time
- Attaches to a household drill to provide you pro-like results
- Dual-action, rotation provides faster and safer results



MEGG3507 DA Powerpads - Cutting Pad



MEGG3508 DA Powerpads - Polishing Pad



MOM05142 PowerBall Mini MD® Polishing Tool with 10" Extension

- Our first ever specialty tool in the PowerBall® family. The PowerBall Mini MD® (Metal Doctor) makes costly wheel repairs a thing of the past
- It allows you to safely and easily remove tough scratches and stains from your polished aluminum and stainless steel parts with speed and confidence



MOM05146 PowerCone® for Powerball

- It makes quick work of any uncoated, polishable metal finish, no matter how intricate the design
- Its ingenious conical shape provides an infinite range of sizes—ideal for getting into tight, difficult-to-reach areas
- Cone's long, tapered side is perfect for polishing broad, curved surfaces



FTZM10180 Mini Buff Ball 3" with 8" Extender Rod



FTZSM10250-50 2" Super Mini Buff Ball with Free Flitz Polish

- 2" Buff Ball
- Helps buff out hard to reach & small areas
- Self-cooling
- Buff out odd shape areas
- Free 1.76 oz Flitz Polish included



FTZWB201-50 7" X-Large Buff Ball with Free Flitz Polish

- 7" X-Large Buff Ball
- Perfect for flat surfaces
- Great for large surfaces
- Quickly buffs out scuff marks
- Free 1.76 oz. Flitz Polish included



⚠ WARNING: Cancer and Reproductive Harm - www.P65Warnings.ca.gov

FTZPB101-50 5" Large Buff Ball with Free Flitz Polish 1.76oz

- 5" Ball fits any 3/8" drill
- Use on all surfaces
- Buffs out brake dust
- Soft fabric cuff covers
- Includes Free 1.76 oz. Flitz Polish



FTZPB101 Buff 'N Polish Ball

- Orbital shape buffs at speeds up to 2500 rpm
- Italian felt will not shed or lint
- Fits on any drill with a 3/8" hex shaft
- Won't cake up - washable up to 10 times
- Hundreds of buffing fingers fits into tight areas, convex, concave or flat



FTZPB100 5" Polishing And Buffing Ball

- 5-inch ball that fits any 3/8" drill or air tool
- Quickly and safely buffs out brake dust, scuff marks, light scratches, oxidation, chalking, tarnish, pitting and corrosion
- Power-rated for speeds up to 2500 rpm



BUFFING AND POLISHING

Pads and Bonnets



MEGW0004-4

Hi Tech Foam Applicator Pad 4 pack

- 4 reusable pads • Spreads product evenly
- Ideal for use on paint, wheels and tires
- Machine washable and very durable

MEGX3080

Even Coat™ Microfiber Applicator Pads

- The ultimate pad for swirl free, show car perfect results
- Gentler than a foam pad, this applicator is ideal for ultra fine polishing and waxing
- 5" surface area allows for faster polishing and waxing



DA Microfiber Cutting Discs (2-pack)

- New microfiber disc technology cuts through moderate surface defects with no swirls...guaranteed!
- Engineered foam interface for optimal cutting and controlled conformability
- Optimized for use with Meguiar's® DA Microfiber Correction Compound (D300)
- Machine washable



- MEGDMC5 - 5"
- MEGDMC6 - 6"

MEGDMX6

6" Microfiber Xtra Cut Disc - 2 Pack

- Microfiber disc technology cuts through severe to moderate surface defects with no swirls
- Engineered for increased cutting efficiency
- Optimized for use with Meguiar's® D300



Soft Buff DA Polisher Backing Plates

- Rotation indicator
- Additional rivets for strength
- Single mounting option, 5/16"-24" Spindles
- One piece construction and all new fiberglass core
- Distributes pressure for smoother sanding and finishing



- MEGDBP5 (5", 5/16"-24 Spindle)
- MEGDBP6 (6", 5/16"-24 Spindle)

MEGWRWHC7

7" Soft Buff Rotary Wool Heavy Cutting Pad

- 1" twisted wool fibers
- Effective removal of sanding marks and defects
- Flat pad design expands cutting area
- Flat pad design reduces buffing cycle time



MEGDMF6

6" DA Microfiber Cutting Discs (2-pack)

- New microfiber disc technology refines surfaces to a high gloss finish
- Engineered foam interface for controlled conformability and optimal finishing
- Optimized for use with DA microfiber finishing wax
- Machine washable

MEGDFC6

6" Soft Buff DA Foam Cutting Disc

- More cutting power, more efficient performance more pad rotation, less operating temperature
- Less "ticking" on surface
- Less chance of DA haze



MEGDFP6

6" Soft Buff™ DA Foam Cutting Discs

- Lower profile, smoother feel
- More cutting power, more efficient performance more pad rotation, less operating temperature



MEGW7207

Softbuff 2.0 Foam Cutting Pad (7")

- 7" Buffing Pad
- Recessed Backing
- Machine Washable



MAK743403-A

7" Wool Polishing Hook and Loop Bonnet

- Recommended use polishing, hook and loop style
- For use with electronic sander-polisher



MLW49-36-5785

Milwaukee® 7 in. Blended Wool Cutting Pad (5-Piece)

- Used for heavy cutting • Easy centering hole
- Replacement pads for the 2738-20 M18 FUEL Polisher
- Quickly align pad for perfect balance and a smooth glide across polishing area
- Can be used on any full size polisher

BUFFING AND POLISHING

Pads and Bonnets



DYB76014

3" Terry-Cloth Buffing Pads

- Great for applying wax and polish
- The terry bonnet is 100% soft, absorbent cotton, like traditional terry towels. Use on 2400 rpm buffer with hook-back up pad for applying or removing wax
- Hook backing



DYB76015

3" Synthetic Wool Pads

- Use with compounds, glazes and polishes
- Durable hook backing for easy attachment to back-up pad
- Great for use with Dynabrade 18055 and 10390 3" Buffers



DYB76016

3" White Foam Polishing Pads

- Ideal for polishing in small areas
- Use with glaze for swirl removal
- Great for use with Dynabrade 18055 and 10390 3" buffers



DYB76000

3" Buffing Pad Kit

- Includes four 3" polishing buffs with hook backing
- Includes terry, wool, white-polishing and yellow-cutting buffs
- Includes 3" hook-face backing pad for mounting buffs
- Also includes 1/4" shank (DYB50125) to mount to tool
- Pads have maximum operating speed of 3,200 RPM



DYB76017

3" Yellow Foam Cutting Pads

- 3" coarse foam ideal for cutting and removing oxidation
- Ideal for repairing scratches, waterspots, and swirl marks
- Small 3" size allows operator to compound in small areas
- Hook backing for easy attachment to back-up pad
- Use with Dynabrade 18055 and 10390 3" buffers



WIZ11250

Mini Buffing System

- Saves time with expert results
- Cut, polish, remove swirls, or apply wax/sealer
- All pads use Velcro® attachments
- Great for tight areas or spot repairs
- Use on paint, metal and plastic surfaces

Includes: WIZ11251 3" Wool Mini Buffing Pad, (cutting), WIZ1252 4" Yellow Foam Mini Buffing Pad, (light cutting), WIZ11253 4" Grey Foam Mini Buffing Pad (final finishing) and WIZ11254 Mini Backing Plate Set with D/A Adapter (standard 5/16") and Drill Adapter (standard 1/4" shank).

WIZ11201

7" Fast Cut Wool Buffing Pad

- Use with all compounds
- Aggressive cutting without burning paint
- All pads use Velcro® attachments
- Use with 6 (11211) or 7 (11207) Bendi-Backer Backing Plate



WIZ11203

7" Finish Cut 50/50 Blend Buffing Pad

- Use with all compounds
- Best overall one-step pad
- Cuts like a cutting pad
- Finishes like a finishing pad
- All pads use Velcro® attachments



WIZ11204

8" Foam Cut Yellow Buffing Pad

- Use with all compounds or polish
- Removes swirls & wool pad marks
- Foam pads offer a no-splatter, no-chatter, patented graduated concave surface that encapsulates the compounds and glazes
- All pads use Velcro® attachments



WIZ11205

8" Foam Polish White Buffing Pad

- Medium cutting foam pad
- Removes swirls on softer clears
- Great follow-up after wool & blend pads
- All pads use Velcro® attachments



BUFFING AND POLISHING

Pads and Bonnets



WIZ11206

8" Foam Finish Gray Buffing Pad

- Use with machine polish, sealant, or glaze
- Light polishing on softer clears
- Follow-up after cutting foam pads
- Universal polish/wax application



WIZ11207

7" Bendi-Backer Backing Plate

- Fits standard size buffer with 0.625 (5/8) arbor
- Soft and Super flexible to foam into style line contours when buffing
- Helps eliminate hot spots and burns
- Compatible with most wool and 7 & 8" foam pads



WIZ11251

3" Wool Mini Buff Pad

- Use on all paints and hard surfaces
- Great for tight areas or spot repairs
- All Pads use Velcro® attachments
- Use with backing plate #11254
- 3" X 1" 100% Tufted Wool



WIZ11310

8" The Aggressor™ Foam Cutting Pad

- Grip hold with recessed backing for fast and easy centering
- Use with all compounds: Mystic Cut™, Turbo Cut™ and Finish Cut™ for super aggressive cutting action
- For added flexibility, use with Bendi-Backer™ 7" backing plate (#11207)



RUP9.BF150H-50

RUPE'S Velcro Polishing Foam Coarse Ø 130/150mm / 1 Carton with 50 Foams

- The oscillating movement of the BigFoot systems is a perfect partner for the porous structure
- The use of Zephir abrasive compound is recommended
- The large dimension of the Rupes Blue Foam Compounding Pad cells dissipates any heat build-up, allowing the compounds to work at optimum levels



RUP9.BF150M-50

Rupes Velcro Polishing Foam Fine Ø 130/150mm / 1 Carton with 50 Foams

- This most versatile of BigFoot pads adapts to the type of compound used
- Its cell structure has a medium/hard consistency



MMM5546

3M™ Stikit™ Low Profile Finishing Disc Pad, 6" x 11/16"

- Utilizes a soft foam construction for fine finish sanding and offers outstanding comfortability to contours and curves
- Use on random orbital sanders only
- 5/16 - 24 External



MMM85078

3" 3M™ Finesse-it™ Knit Buffing Pad

- 15/16" pile height
- Made from wool fibers for applying the Finesse-it™ Finishing Material or Finesse-it™ Final Finish
- Has a Hookit™ attachment system
- Use with disc pad 05769



MMM5711

3M™ Wool Compounding Pad

- Single Sided Blended wool compounding pad used to refine P1200 and finer sand scratches and other paint surface defects
- Use with 3M™ Compounds and 3M™ Hookit™ back up pads
- Removes finishing abrasive sand scratches and other surface defects
- Untwisted wool yarn construction improves handling across large surface areas



MMM5723

8" 3M™ Perfect-It™ Foam Compounding Pad

- Convoluted foam face design holds compounds better, reduces slinging of compound
- Attaches to either 3M™ Compounding and polishing back up pads MMM05717 or MMM05718
- Maximum operating speed: 2,000 rpm



MMM5725

8" 3M™ Perfect-It™ Foam Polishing Pad, 2 Pads per Bag

- Convoluted foam face produces wheel/swirl free paint finish when used with 3M™ Perfect-It Foam Polishing Pad Glazes
- Attaches to either 3M™ Hookit™ Back Up Pad MMM05717 or 3M™ Perfect It™ Back Up Pad MMM05718
- Maximum operating speed: 2,000 rpm



MMM5776

3M™ Hookit™ Disc Pad, 6"

- The pad face securely holds the discs yet allows for easy change of discs
- Lightweight, shock resistant and well-balanced
- The tough, durable plastic hub and a foam body are designed for a max operating speed of 7,000 rpm



BUFFING AND POLISHING

Pads and Bonnets



BUFTP-4

7 Piece Mini Buffing Pad Kit

- Foam pads are made of high quality foam to deliver precision polishing and finishing steps
- Wool pad is made of high quality wool to deliver precision cutting power
- All pads have hook and loop backing for fast and easy mounting while buffing

BUF7502GT

7-1/2" Wool Self Centering Polishing / Buffing Pad

- 100% wool • 4 ply twist grip
- 1-1/4 in. pile (natural)
- Suggested RPM is 1700-2400



BUF7503G

7-1/2" 4 Ply Twist Grip Buffing Pad

- 100 % wool • 4 ply twist grip
- 1-1/2" pile (natural)
- Suggested RPM: 1750-2400



SMASSP-589

Speedy Surface Prep Towel

- Speedy Surface Prep Quickly removes contaminants from the surface
- Leaves surface smooth as glass
- Removes industrial pollutants, paint overspray, brake dust
- Removes contaminants from paint, glass, molding and fiberglass
- Easy to maintain



SGT87975

Buffing Bonnet Cleaning Tool

- Extends life of all buffing pads and bonnets without taking them off the polisher
- Cleans and revitalizes in one operation
- Removes glazed surface and fluffs packed wool



WARNING: Cancer and Reproductive Harm - www.P65Warnings.ca.gov

Bufs

WARNING: Cancer and Reproductive Harm - www.P65Warnings.ca.gov



AST3059-03

3" 100% Cotton Mushroom Shaped Buff

- For buffing in tight corners
- Features a hex shaped shaft with a quick coupling mechanism
- No tools needed to switch the buffs



AST3059-04

4" 100% Cotton Mushroom Shaped Buff

AST3059-05

3" 100% Cotton Tapered Buff

- Great for recessed areas
- Features a hex shaped shaft with a quick coupling mechanism
- No tools needed to switch the buffs

AST3059-06

2" 100% Cotton Drum Buff

- Great for rim edges and flat surfaces
- Features a hex shaped shaft with a quick coupling mechanism
- No tools needed to switch the buffs



WIZ11094

Medium Felt Metal Buff, 1/4" Shank

- 3/4" diameter x 1 1/2"
- 1/4" shank fits most electric or air drills
- Cutting and oxidation removal in very small areas and tight corners
- Use with Metal Renew™ #11020, for fast, effective power polishing on all types of metal surfaces



CAULKING GUNS & CAULK



- KT183285
Caulking Gun,
Steel Half Barrel Style**
- Lightweight & strong • Thrust ratio: 7:1
 - Quick release push rod
 - Retractable seal puncture tool
 - For use with sealants in standard tube cartridges: low viscosity latex, vinyl and acrylic caulks
 - Covered by a 90 day Warranty on material and workmanship

**KT183285-12
Caulking Gun, Steel Half Barrel Style
- 12 Pack**



- KT183286
Caulking Gun, Steel,
Drip Free Open Frame Style**
- Lightweight & strong
 - Drip free automatic ratchet advance; Push rod is quick release hex; includes a ladder hook
 - Built in nozzle cutter and retractable seal puncture tool

**KT183286-12
Caulking Gun, Steel Drip Free -
12 Pack**

WARNING: Cancer and Reproductive Harm - www.P65Warnings.ca.gov



- ANCSTEMB1
Adhesive Dispensing Gun**
- Dispenses any adhesive from aluminum type adhesive tubes
 - Comfortable ergonomic grip
 - Rugged construction for extreme durability
 - Lifetime warranty • Patent pending



- AST405
Air Caulking Gun**
- Permits smooth flow caulking
 - Dispense caulk, adhesives and sealants from standard cartridge
 - Air Pressure: 40-69 PSI
 - Tube Length: 8-1/4"



- AST4531
Air Caulking Gun**
- Dispenses caulking, adhesive and sealant from a standard cartridge or bag
 - Includes: one plastic nozzle for use with bag
 - Thrust ratio: 12:1 • Manual use

WARNING: Cancer and Reproductive Harm - www.P65Warnings.ca.gov



- MMM8992
3M™ Catridge Applicator Gun**
- For use with 3M 1/10 gallon cartridge adhesives and sealants



- MMM8571
3M™ Standard Manual
Applicator, 200 ml**
- Dispenses all 3M™ 200 ml cartridges with 1-1or 2-1 mix ratios
 - Heavy duty metal construction
 - Rod driven for balanced product dispensing
 - Heavy duty metal construction



- SGT19300
Heavy Duty
Caulking Gun**
- Push rod design dispenses a smooth flow of sealants and compounds from 1/10 gallon cartridges
 - Completely empties cartridge
 - Quick release trigger removes pressure and stops material flow
 - Epoxy coated steel and die cast construction

WARNING: Cancer and Reproductive Harm - www.P65Warnings.ca.gov



- SGT19330
Air Powered Caulking Gun**
- Top quality air caulking gun quickly and efficiently dispenses a wide variety of caulking and sealants
 - 8-1/2" long cylinder accommodates all standard caulking cartridges
 - Rugged design all metal body for reliable, everyday operation
 - 1/4" NPT female air inlet; air consumption at 4 CFM; recommended operating pressure is 50-70 PSI

WARNING: Cancer and Reproductive Harm - www.P65Warnings.ca.gov



- MMM8578
3M™ Strip Caulk, Black,
60 - 1' Strips per Box**
- Soft non-hardening caulking material in one foot lengths for use in all types of seams, joints and openings
 - Product is easily thumbed into place and smoothed with a finger
 - Non-sag consistency for vertical and overhead applications
 - No shrinkage - adheres to metal, paint, glass and rubber
 - Completely waterproof and will not dry out or crack

SEALANTS & HARDENERS

3M



MMM8551

3M™ Clear Auto Sealer, 5 Fl. Oz.

- Clear, fast drying, sealant that stays flexible and is color stable
- This product is used for sealing leaks in windshields, backlites, reveal moldings, truck ornaments, taillights and other small seams on the autobody



MMM8405

3M™ Flexiclear™ Body Seam Sealer, 1/10 Gallon Cartridge

- High solids clear joint and seam sealer designed to seal interior and exterior joints and seams
- Adheres well to clean, bare metal, primed metal and painted surfaces
- Clear, non-yellowing
- Excellent tooling properties
- Can be painted quickly, remains flexible



MMM8505

3M™ Fast N Firm™ Seam Sealer, 1/10 Gallon Cartridge

- Firm setting product for sealing interior and exterior joints
- Adheres well to clean, bare metal, primed metal and paint surfaces
- Skins over quickly, low shrinkage
- Can be painted within 30 minutes
- Excellent tooling and sanding properties

3M



3M™ Windo-Weld™ Round Ribbon Sealers

- Contains one roll of sealer and setting blocks
- Its unique feature of controlled compressibility allows easy installation yet will not squeeze out or allow lite to contact pinchweld
- Sufficient material to replace one windshield or backlite

MMM8610 - 1/4" x 15'

MMM8611 - 5/16" x 15'

MMM8612 - 3/8" x 15'

SEM



SEM40377

Dual Mix Heavy Bodied Black Seam Sealer

- OEM recommended
- Direct to metal
- Paintable immediately
- Holds tooling marks throughout working time
- Non-sag formula

⚠️ **WARNING:** Cancer and Reproductive Harm - www.P65Warnings.ca.gov

Cream Hardeners

EVERCOAT®



Cream Hardeners

- Great for fast processes
- Ideal for body repair
- Quick hardening, non-separating, cream hardeners formulated for use with bodyfillers, specialty fillers and polyester finishing putties
- Formulated design
- Works with a multitude of fillers

FIB354 - Blue 2.75 oz.

FIB358 - Red 2.75 oz.

FIB340 - White 4 oz.

FIB359 - Blue 4 oz.

HEADLIGHT RESURFACING KITS



FTZHR31501

Headlight Restoration Kit

- Removes haziness from plastic headlights in one easy step
- Complete kit includes everything needed to restore headlights, tail lights, windshields, plastic camper windows, helmet face shields, boat hatches, light bars, bug deflectors
- Buff Ball made of high quality fabric from Italy
- Buff Ball will attach to any drill with 3/8" hex shaft - washable and reusable
- Polish included is a multi-purpose polish for metals, plastics and fiberglass



MMM02516

3M™ Headlight Lens Restoration System

- Includes 3" polisher and 3" DA sander
- The fast and easy way to restore the clarity back to headlight lenses that have become dull or cloudy over time
- Designed with the professional in mind to maximize productivity and performance



SYM75010030

Pro Series Headlight Restoration/Preserver Kit

- Restores "like new" appearance to discolored headlamps
- Seals/Preserves headlamps that last for years
- Services 35-to-40 vehicles • Easy 3 step process

Kit includes: vinyl gloves, pre-treatment, oxidation remover, shine restorer, deep fill restorer, Sand E-Z sand paper, lint free towels.



SYM75010090

Platinum Series

Headlamp Restoration Kit

- Restores, shines, preserves headlamps for many years
- Services up to 70 vehicles • Includes 3' DA palm sander
- 600 and 1500 grit sanding pads, buffing pads
- Comes in a 12" tool box

MMM39008

3M Headlight Lens Restoration System

- 3M abrasive technology and a polishing compound to restore hazy and dull headlight lenses, as well as other plastic lens surfaces on your vehicle
- System is intended to restore two headlight lenses
- Utilizes the muscle power of a common household (1200-1600 rpm) drill (not included) to do all the necessary sanding and buffing
- Easy, 3-step process requires as little as an hour to remove scratches and restore cloudy, dull lenses



MOM07250

PowerBall 4 Lights Headlight Restoration Kit

- Easily cleans away yellowing and stains, and even buffs out unsightly hairline scratches, smudges and flaws in a single step
- Include polishing tool, 8 ounce polish, 2 restoration pads and a 15 inch x 15 inch microfiber towel
- Designed to quickly and safely restore, maintain and protect all types of smooth plastic headlights

The included PowerPlastic Polish restores crystal clarity; leaving a tough protective oxidation inhibiting polymer layer to guard against future degradation from the elements. Kit Includes- Polishing Tool; 8 ounce PowerPlastic; Two Restoration Pads; 15 inch x 15 inch Microfiber Towel.

PAINT AND SUPPLIES

Dupli-Color®



Custom Wrap Removable Coatings

- Exclusive Automotive Formulation with EZ Peel Technology
- Smooth Professional Looking Finish
- Customize And Remove
- Dry To Touch In 30 Minutes / Handle In 1 Hour

Dupli-Color® Custom Wrap is specifically formulated for automotive customization. Custom Wrap provides a smooth, professional looking finish that resists the wear and tear of daily driving. To try a new color or go back to the original surface, this exclusive formulation also features our EZ Peel® Technology for quick removal. Ideal for application over: OEM painted surfaces, aluminum, metal, chrome and plastic.

- DUPCWRC797** - 11 oz. Aerosol, Matte Graphite
- DUPCWRC798** - 11 oz. Aerosol, Matte Arctic White
- DUPCWRC840** - 11 oz. Aerosol, Gloss Midnight Black
- DUPCWRC841** - 11 oz. Aerosol, Gloss Modern White
- DUPCWRC842** - 11 oz. Aerosol, Gloss True Blue
- DUPCWRC843** - 11 oz. Aerosol, Gloss Racing Red
- DUPCWRC860** - 11 oz. Aerosol, Outrageous Orange
- DUPCWRC861** - 11 oz. Aerosol, Intense Yellow
- DUPCWRC862** - 11 oz. Aerosol, Electric Lime
- DUPCWRC863** - 11 oz. Aerosol, Brilliant Blue
- DUPCWRC864** - 11 oz. Aerosol, Vibrant Violet
- DUPCWRC865** - 11 oz. Aerosol, Dynamic Pink

- DUPCWRC870** - 2-Can Kit- 11 oz. Aerosol, Blue Glow in the Dark
- DUPCWRC871** - 2-Can Kit- 11 oz. Aerosol, Green Glow in the Dark
- DUPCWRC900** - 11 oz. Aerosol, Matte Clearcoat
- DUPCWRC901** - 11 oz. Aerosol, Gloss Clearcoat
- DUPCWBG794** - 1 Gallon, Matte Carbon Black
- DUPCWBG797** - 1 Gallon, Matte Graphite
- DUPCWBG798** - 1 Gallon, Matte Arctic White
- DUPCWBQ797** - 1 Quart, Matte Graphite
- DUPCWBQ798** - 1 Quart, Matte Arctic White

PAINT AND SUPPLIES

Dupli-Color®

DUPTB101 Trim and Bumper Spray 11 oz. Aerosol, Black

- Renews and protects discolored bumpers
- For use on thermoplastic and polyurethane bumpers
- Dries in 30 minutes
- Made in USA



Dupli-Color® Trim & Bumper Paint features Fade-X™ Technology to ensure a long-lasting finish for exterior and interior applications. This specialty formulation restores trim & bumper surfaces back to their factory-look.



Clear Truck Bed Coatings

- Versatile All-Purpose Protective Coating
- Durable Impact Resistant Coating
- Textured Clear Finish
- Rust resistant

Dupli-Color® Clear Truck Bed Coating protects truck beds at a fraction of the cost of conventional drop-in truck bed liners. Dupli-Color Clear Truck Bed Coating is designed for the do-it-yourself user and is available with multiple application methods. It can be applied using a roller, spray gun, or aerosol spray can making it ideal for use as an all-purpose protective coating for truck beds, inner fenders, tailgates, bedrails, cargo vans, step areas, and running boards.

- DUPCTBQ100** - 1 Quart
- DUPCTBG100** - 1 Gallon
- DUPCTBA100** - 16.5 Aerosol



DUPTRG252 Truck Bed Coating - Round Gallon

- Versatile all-purpose protective coating
- Durable impact resistant coating
- Dry to touch in 1 Hour / Handle in 2 Hours
- Use on truck beds, Jeep tubs, and frames
- Unique black polymer that gives the look and protection of a conventional truck bed liner for a fraction of the price

Dupli-Color®



Rust Barrier

- Seals Corrosion
- Paintable
- Impact resistant

Dupli-Color® Rust Barrier High Solids Rust Preventive Coating is formulated to be applied directly over rusted or bare metal surfaces. Using our exclusive Rust Barrier Technology, this coating seals corrosion and provides an abrasive, impact resistant, flexible rubberized finish. Rust Barrier is easy to apply by brush, roller, HVLP spray gun or aerosol. If needed, this product can be topcoated for areas exposed to increased UV light.

- DUPRBQ100** - 1 Quart, Flat Black
- DUPRBQ101** - 1 Quart, Gloss Black
- DUPRBQ102** - 1 Quart, Silver
- DUPRBG100** - 1 Gallon, Flat Black
- DUPRBA100** - 11 oz. Aerosol, Flat Black
- DUPRBA101** - 11 oz. Aerosol, Gloss Black
- DUPRBA102** - 11 oz. Aerosol, Silver

Dupli-Color Trunk Spatter Paint 11 oz. Aerosol

- Durable Impact Resistant Coating
- Textured Clear Finish
- Rust resistant

Dupli-Color® Clear Truck Bed Coating can be applied using a roller, spray gun, or aerosol spray can making it ideal for use as an all-purpose protective coating for truck beds, inner fenders, tailgates, bedrails, cargo vans, step areas, and running boards.



- DUPTSP100** - Gray and White
- DUPTSP101** - Black and Gray

DUPDAP1700 2-in-1 Hi-Build Filler and Sandable Primer 12 oz. Aerosol

- Features EZ Touch® Fan Spray Nozzle
- Fills Deep Scratches And Minor Imperfections
- Improves Top Coat Adhesion
- High Build Formula
- Easy Sanding Properties
- Ideal for use on metal, fiberglass and wood.



PAINT AND SUPPLIES

Dupli-Color®



Farm and Implement Paints - 1 Quart

- Direct to metal application
- Corrosion resistant
- High gloss finish
- Fast dry time

DUP2023 - John Deere Green

DUP2024 - International Harvester Red

DUP2025 - John Deere Yellow

DUP2030 - Allis Chalmers Orange

DUP2035 - New Holland Red

DUP2038 - School Bus Yellow

DUP2042 - Old Equipment Cat Yellow

Perfect Match Premium Automotive Paints - 8 oz. Aerosol

- Premium Automotive Paint
- Matches OEM Color
- Ensures Maximum Coverage
- Dry To Touch In 30 Minutes / Handle In 1 Hour



Dupli-Color® Perfect Match® Premium Automotive Paint is an easy-to-use, high-quality, fast-drying, acrylic lacquer aerosol paint specially formulated to match the exact color of the original factory applied coating. Ideal for use on all OEM paint surfaces, Perfect Match is available in a complete line of exact-match colors for current and late model import and domestic vehicles, making this product ideal for both small scale vehicle touch-up and for painting vehicle accessories.

DUPBNS0568

Aztec Red (Paint Code AG2)

DUPBNS0606

Majestic Blue (Paint Code BW9)

DUPHSK100

Hyper Silver Wheel Kit

- Everything you need to dip your wheels Hyper Silver
- Backed by manufacturer's warranty
- Great Performance



Dupli-Color®

DUPBCL0125

Perfect Match Automotive Paint, Clear Top Coat, 8 oz Aerosol Can



- Features EZ Touch 360° nozzle
- Premium automotive paint
- Duplicates original Chrysler colors
- Ensures maximum coverage
- Dry to touch in 30 minutes / handle in 1 hour



DUPBFM0341

Perfect Match Automotive Paint, Ford Silver Frost, 8 oz. Aerosol Can

- Duplicates original Ford colors



DUPHWP101

High Performance

Silver Wheel Paint - 12 oz.

- Highly reflective metallic finish
- Fast dry
- Rugged acrylic enamel formula
- Improved resistance to brake dust, chemicals and chipping
- This item is not for sale in Catalina Island



SEM15013

Color Coat - Landau Black Aerosol

- Excellent for vinyl, plastic, carpet and velour
- Elastometric coating will not crack
- Superior adhesion, flexibility and hiding



SEM15243

Color Coat - Satin Black Aerosol

⚠ WARNING: Cancer and Reproductive Harm - www.P65Warnings.ca.gov



SEM39143

Trim Black

- Restores faded and peeling exterior trim parts
- Maximum adhesion on stainless steel and chrome

⚠ WARNING: Cancer and Reproductive Harm - www.P65Warnings.ca.gov

DEVILBISS®

DEV803491

Dirt Control Floor Coat, 5 Gallon

- Reduces airborne particles in the spray booth by over 50% and traps them on the floor
- Reduces buffing time caused by dirt in the paint job
- Ideal for shops spraying waterborne as increased air movement and low humidity are required
- Easy to use, intended for non-painted, concrete floors
- Traps particles on the floor, not on the vehicle, water-based, low VOC



⚠ WARNING: Cancer and Reproductive Harm - www.P65Warnings.ca.gov



PRIMERS AND RUST PROOFING

JP Astro



WARNING: Cancer and Reproductive Harm - www.P65Warnings.ca.gov

AST4583F

Nylon Mesh Paint Strainer (Fine)

- Filters imperfections in paints / varnishes
- 1000 pieces per case

AST4586

12" Bamboo Paint Paddle

- 1,000 per case

SATA

Spray Equipment

**SATDAA1001K
DanAm Air Vac
Complete Kit with
12 Disposable Tips**

- Removes bugs and debris from fresh clear coat
- Can pull drops of sweat off a fresh painted panel
- Built with high quality aluminum
- 4' black suction hose



Made in U.S.A.



Made in U.S.A.



MEGC2000

**Mirror Glaze Professional Detailing
Overspray Clay (Mild)**

- The safe, chemical-free way to remove stubborn contamination
- Uniquely formulated
- Removes surface imperfections such as sap, over-spray, rail dust and much more



Made in U.S.A.



TSL3513

**One-Step® Rust Converter
Primer Sealer - 1 Quart**

- Converts rust into a hard, black primer sealer
- Water-based latex containing rust modifiers, which is designed for application directly over tightly bonded rust on iron or steel
- Proven effective on new degreased or mild steel where flash-rusting has occurred

SEM

SEM39133

Flexible Primer Surfacer

- Quick drying
- Easy to sand
- Flexible formulation
- Topcoat with most refinish materials



Flexible Prime Surfacer provides superior film build and flexibility when coating urethanes, plastics and other similar substrates.

Self Etching Primer

- Adheres to steel, aluminum and stainless steel, for overall refinishing or spot repairs

SEM39673 - Black

SEM39683 - Gray

SEM39693 - Green



SEM39783

Weld-Thru Primer

- Eliminates corrosion that forms between welded substrates



WARNING: Cancer and Reproductive Harm - www.P65Warnings.ca.gov

UNDER CARRIAGE & UNDER COATING PRODUCTS

3M

MMM8881

3M™ Undercoating, 16 Oz.

- Black, multi-purpose, low cost, aerosol undercoating
- Specifically used for undercarriages, wheel wells, frame rails, and fenders
- Designed to protect metal from corrosion and abrasion
- Can also be used as a sound dampening coating



MMM8883

**3M™ Rubberized
Undercoating**

- Provides rust-proofing and sound deadening for a variety of applications, including fenders, quarter panels, door panels, repaired sections, welded joints, hood and decklids
- Use with 128 Bondo® Easy Finish® Aerosol Trigger



**Chassis Saver Paint, Stops
and Prevents Rust, Satin Black**

- High solids, VOC compliant, single component chassis paint and underbody coating
- Specially formulated to permanently stop automotive and truck corrosion without the use of primers or topcoats
- Bonds to blasted and rusty metal to for a rock hard yet flexible, glaze-like, non-porous finish that won't crack, chip, flake or peel
- Cures by reacting with atmospheric moisture and its cured film resembles that of a catalyzed finish yet no hardeners or activators are used

MPCUCP970-04 1 Quart Can

MPCUCP970-01 1 Gallon Can



MPCUCP99-04

**Chassis Saver Paint, Stops
and Prevents Rust, Gloss Black,
1 Quart Can**

- High solids, VOC compliant, single component chassis paint and underbody coating
- Specially formulated to permanently stop automotive and truck corrosion without the use of primers or topcoats
- Optimum results can be achieved by sandblasting a medium blast profile to surfaces
- Bonds to blasted and rusty metal to for a rock hard yet flexible, glaze-like, non-porous finish that won't crack, chip, flake or peel
- Cures by reacting with atmospheric moisture and its cured film resembles that of a catalyzed finish yet no hardeners or activators are used

PINSTRIPING TAPE



1/8"



MMM702-02

3M™ Scotchcal™ Striping Tape, Black, 1/8" x 40'

- Single stripe pattern for professional use in matching existing stripes or creating original striping designs on vehicles
- This pattern can be used to repair an existing stripe or create a new look on any vehicle
- Basic construction is a premium cast 2 mil vinyl film coated with an OEM approved adhesive
- Resists gasoline and chemicals

3/16"



MMM720-01

3M™ Scotchcal™ Striping Tape, White, 3/16" x 150' Roll



- Double stripe pattern using one color for professional use in matching existing stripes or creating original striping designs on vehicles
- This pattern can be used to repair an existing stripe or create a new look on any vehicle
- Basic construction is a premium cast 2 mil vinyl film coated with an OEM approved adhesive

Part #	Size	Color
MMM720-02	3/16" x 150' Roll	Black
MMM720-03	3/16" x 150' Roll	Gold Metallic
MMM720-05	3/16" x 150' Roll	Silver Metallic
MMM720-14	3/16" x 150' Roll	Light Slate Metallic
MMM720-17	3/16" x 150' Roll	Tan
MMM720-19	3/16" x 150' Roll	Medium Gray
MMM720-28	3/16" x 150' Roll	Pewter
MMM720-50	3/16" x 150' Roll	Light Charcoal Metallic
MMM720-85	3/16" x 150' Roll	Light Gold Metallic

3/8"



3M™ Scotchcal™ Striping Tape

- Double stripe pattern using one color for professional use in matching existing stripes or creating original striping designs on vehicles
- This pattern can be used to repair an existing stripe or create a new look on any vehicle
- Basic construction is a premium cast 2 mil vinyl film coated with an OEM approved adhesive

MMM725-05 - Silver Metallic, 3/8" Double 150'

MMM725-14 - Light Slate Metallic, 3/8" x 150'



Pinstripe 1/8" x 150' Rolls

- Double stripe pattern using one color for professional use in matching existing stripes or creating original striping designs on vehicles
- This pattern can be used to repair an existing stripe or create a new look on any vehicle
- Basic construction is a premium cast 2 mil vinyl film coated with an OEM approved adhesive



MMM732-02 - Black

MMM732-05 - Silver Metallic



MMM723-02

3M™ Scotchcal™ Striping Tape, Black, 5/16" x 150'

- Double stripe pattern using one color for professional use in matching existing stripes or creating original striping designs on vehicles
- This pattern can be used to repair an existing stripe or create a new look on any vehicle
- Basic construction is a premium cast 2 mil vinyl film coated with an OEM approved adhesive



Part #	Size	Color
MMM723-03	5/16" x 150' Roll	Gold Metallic
MMM723-05	5/16" x 150' Roll	Silver Metallic
MMM723-28	5/16" x 150' Roll	Pewter
MMM723-50	5/16" x 150' Roll	Light Charcoal Metallic
MMM723-63	5/16" x 150' Roll	Charcoal Metallic
MMM723-79	5/16" x 150' Roll	Pale Gray
MMM723-85	5/16" x 150' Roll	Light Gold Metallic

1/2"



MMM724-02

3M™ Scotchcal™ Striping Tape, Black, 1/2" x 150'

- Double stripe pattern using one color for professional use in matching existing stripes or creating original striping designs on vehicles
- This pattern can be used to repair an existing stripe or create a new look on any vehicle
- Basic construction is a premium cast 2 mil vinyl film coated with an OEM approved adhesive



Part #	Size	Color
MMM724-03	1/2" x 150' Roll	Gold Metallic
MMM724-05	1/2" x 150' Roll	Silver Metallic
MMM724-28	1/2" x 150' Roll	Pewter
MMM724-50	1/2" x 150' Roll	Light Charcoal Metallic
MMM724-63	1/2" x 150' Roll	Charcoal Metallic

SPREADERS



MTN4526

**4" Plastic Spreaders
100 Pieces Per Box**

- Ideal for spreading body filler

WARNING: Cancer and Reproductive Harm - www.P65Warnings.ca.gov



MAR20395

**Marson® Yellow Spreaders -
150 per case**

- Plastic spreaders are specially designed for body repair professionals
- The flexible spreading edge makes precise application of body fillers, putties and glazes
- These long lasting tools allow cured body filler to easily pop off the spreader for additional use



CASE OF 36

DYN363

**Spreaders 3" X 6"
(36 per Case)**

- A special flexible spreading edge makes precise application of body fillers, putties and glazes a breeze
- Cured body filler will pop off and spreader, allowing for multiple reuse



BODY FILLER



FIB400

**Polyester Glazing
Putty - Quart**

- Can be applied directly to bare metal, body filler, fiberglass and fully cured sanded top coats
- Easily fills grind marks, pinholes, low spots and other minor imperfections
- Contains ZNX-t™ for superior adhesion to galvanized steel, bare steel, aluminum, SMC, E-Coat and OEM finishes
- Blue cream hardener included



FIB411

**Poly-Flex™ Flexible
Polyester Glazing
Putty - 30 oz**

- Designed for spot filling and skim coating over repair areas on flexible bumpers and plastic parts
- Its flowable viscosity is ideal for filling minor imperfections such as sand scratches, nicks, dings and gouges
- Blue cream hardener included



FIB416

**Metal Glaze®
Putty - 30 oz.**

- Two-part polyester finishing and blending putty
- Includes ZNX-7™ for adhesion to galvanized metal, aluminum, steel, SMC and O.E.M. paint
- Extra thin formula, spreads smoothly
- Easily fills grind marks, pinholes, uneven surfaces and other minor imperfections
- Ideal for intermixing with other Metalworks® body fillers and glazing putties to enhance their ease of working



FIB417

**Glaze Coat
Putty 30oz**

- Like Metal Glaze®, Glaze Coat is vacuumed processed for reduced pinholes and offers the same features, benefits and performance as Metal Glaze®, in a buff colored formula
- White cream hardener included



FIB156

**Light Weight®
Non-Clog
Lightweight
Body Filler,
Gallon**

- #1 selling, high quality, clog free, lightweight body filler is a great value with its smooth spreading, easy sanding features
- Non-clog formula adds greater value in sandpaper savings
- Blue cream hardener included



FIB157

**Lite Weight® Non-Clog Lightweight
Body Filler, Quart**

FIB282

**Z-Grip® Non-Clog
Lightweight Filler
- Gallon**

- An advanced clog-free, lightweight body filler for today's high tech metals
- Formulated with ZNX-7™ for superior adhesion to galvanized steel, bare steel and aluminum
- Honors the OEM corrosion warranty
- Blue cream hardener included



FIB284

**Z-Grip® Non-Clog Lightweight Filler
- 3 Gallon Pail**

FIB622

**Everglass® Body
Filler - Gallon**

- Short strand, fiberglass reinforced body filler
- High strength, high build and waterproof which makes it excellent for repairing holes, rusted metal, body seams and shattered fiberglass
- Contains ZNX-7™ for superior adhesion and corrosion resistance to bare steel, galvanized steel and aluminum
- Blue cream hardener included



BODY FILLER

EVERCOAT®

**FIB106
Rage® Premium
Lightweight
Body Filler, Gallon**

- Formulated with the finest resin available
- Tack free and stain resistant, which extends the life of sandpaper and reduces the chance of staining
- Superior spreading and sanding properties eliminate the need for cheese grating or sanding with coarse papers
- Advanced formula with ZNX-7™ provides superior adhesion to galvanized steel, aluminum, SMC and sanded OEM finishes
- Part of the MetalWorks™ System
- Blue cream hardener included



**FIB105
Rage® Premium Lightweight
Body Filler, Quart**

**FIB112
Rage® Gold
Premium
Lightweight Body
Filler, Gallon**

- The unsurpassed sanding qualities are attributed to Hattonite™, a unique ingredient which reduces heat and friction created by aggressive sanding, Rage® Gold also contains ZNX-7™ for adhesion to galvanized steel and aluminum
- Stain resistant for use with basecoat/clearcoat paints
- Blue cream hardener included
- Truck/Hazmat shipping charges apply



**FIB1189
Rage® Premium Lightweight
Body Filler, Quart**

- Evercoat's® easiest sanding body filler
- The unsurpassed sanding qualities are attributed to Hattonite™, a unique ingredient which reduces heat and friction created by aggressive sanding, Rage® Gold also contains ZNX-7™ for adhesion to galvanized steel and aluminum
- Stain resistant for use with basecoat/clearcoat paints
- Blue cream hardener included
- Truck/Hazmat shipping charges apply

EVERCOAT®

**FIB1190
Tiger Hair® Long
Strand Fiberglass
Reinforced Body
Filler, Gallon**

- The original long fiber, fiberglass reinforced filler
- Extra high strength and waterproof
- Can be used with or without fiberglass cloth or mat
- Blue cream hardener included



**FIB120
Rage® Extreme™
Premium
Lightweight Body
Filler, Gallon**

- This technically-advanced, unique formula is self-leveling for easy spreading
- Easily sands with 80 grit sandpaper, eliminating the need for coarse grits that can cause sand scratch swelling
- Contains Evercoat® ZNX-7® which quickly provides superior adhesion to galvanized steel and aluminum
- Blue Cream hardener included



**FIB632
Everglass® Body
Filler - Quart**

- Short strand, fiberglass reinforced body filler
- High strength, high build and waterproof which makes it excellent for repairing holes, rusted metal, body seams and shattered fiberglass
- Contains ZNX-7™ for superior adhesion and corrosion resistance to bare steel, galvanized steel and aluminum
- Blue cream hardener included



**FIB838
Chrome-A-Lite™
Body Filler - Gallon**

- Gold colored, high quality, lightweight body filler with smooth texture providing easy application, excellent adhesion and superb featheredge.
- Non-clog formula saves on labor and materials
- Blue cream hardener included



3M

**MMM5096
Acryl-Green
Spot Putty 14.5 Oz Tube**

- Fast drying formula
- Easy sanding putty designed for spot repairs
- Spreads with ease
- Can be sanded in 10 to 15 minutes
- Less sand paper loading than other putties



**MMM8889
Rocker Panel
Coating 21 Oz. Can**

- Designed to protect lower auto body panels from damage such as stone chipping
- Produces a textured finish which resists chipping, abrasion, rusting and weathering
- Developed to match OEM medium to coarse textures
- Fast drying, paintable, and offers excellent sound deadening properties



SEM

**SEM39853
16 oz. Texture Coating**

- Duplicates OEM textures
- Fast topcoat time
- Ready to spray formula
- Quickly restore exterior and interior texture
- 90 day warranty on material and workmanship

⚠ WARNING: Cancer and Reproductive Harm - www.P65Warnings.ca.gov



marson®

**MAR01171
Marson Platinum® Filler - Gallon**

- Stain-free, tack-free, super premium lightweight filler that offers the industry's best adhesion to steel, galvanized steel, aluminum, E-coat and SMC
- The smooth and creamy texture of Platinum® filler makes it easy to apply and a breeze to sand

